



A Trusted Technology Partner

JUNE 2024



Safe Harbor Statement

Certain statements in this presentation are “forward-looking statements” within the meaning of the Private Securities Litigation Reform Act of 1995 and are based on current expectations and assumptions that are subject to risks and uncertainties. All statements contained in this news release that do not relate to matters of historical fact should be considered forward-looking statements, and are generally identified by words such as “expect,” “intend,” “anticipate,” “estimate,” “believe,” “future,” “could,” “should,” “plan,” “aim,” and other similar expressions. These forward-looking statements include, but are not limited to, statements regarding anticipated financial performance and financial position, including our financial outlook for the full year of 2024; expectations for our end markets and market position; our competitive position, including our positioning for long-term growth and other statements that are not historical facts.

These forward-looking statements are neither promises nor guarantees, but involve risks and uncertainties that may cause actual results to differ materially from those contained in the forward-looking statements. Our actual results could differ materially from those anticipated in these forward-looking statements for many reasons, including, but not limited to, the following: economic and political conditions and the effects of these conditions on our customers’ businesses, capital expenditures and level of business activities; risks associated with epidemics, pandemics or other public health crises, such as the COVID-19 pandemic; our dependence upon our ability to respond to fluctuations in product demand; our ability to continuously innovate, to introduce new products in a timely manner, and to manage transitions to new product innovations effectively; customer order timing and other similar factors; disruptions or breaches in security of our or our third-party providers’ information technology systems; risks associated with our operations in foreign countries; our increased use of outsourcing in foreign countries; risks associated with increased outsourcing of components manufacturing; our exposure to increased tariffs, trade restrictions or taxes on our products; violations of our intellectual property rights and our ability to protect our intellectual property against infringement by third parties; risk of losing our competitive advantage; our failure to successfully integrate recent and future acquisitions into our business; our ability to attract and retain key personnel; our restructuring and realignment activities; product defects or problems integrating our products with other vendors’ products; disruptions in the supply of certain key components and other goods from our suppliers; our failure to accurately forecast component and raw material requirements leading to additional costs and significant delays in shipments; production difficulties and product delivery delays or disruptions; our exposure to extensive medical device regulations, which may impede or hinder the approval, certification or sale of our products and, in some cases, may ultimately result in an inability to obtain approval or certification of certain products or may result in the recall or seizure of previously approved or certified products; potential penalties for violating foreign and U.S. federal and state healthcare laws and regulations; impact of healthcare industry cost containment and healthcare reform measures; changes in governmental regulations related to our business or products; actual or perceived failures to comply with applicable data protection, privacy and security laws, regulations, standards, and other requirements; our failure to implement new information technology systems successfully; changes in foreign currency rates; our failure to realize the full value of our intangible assets; our reliance on original equipment manufacturer customers; increasing scrutiny and changing expectations from investors, customers, governments and other stakeholders and third parties with respect to corporate sustainability policies and practices; the effects of climate change and related regulatory responses; our exposure to the credit risk of some of our customers and in weakened markets; being subject to U.S. federal income taxation even though we are a non-U.S. corporation; changes in tax laws and fluctuations in our effective tax rates; any need for additional capital to adequately respond to business challenges or opportunities and repay or refinance our existing indebtedness, which may not be available on acceptable terms or at all; our existing indebtedness limiting our ability to engage in certain activities; volatility in the market price for our common shares; and our failure to maintain appropriate internal controls in the future.

Any or all of our forward-looking statements may turn out to be inaccurate, and there are no guarantees about our performance. The factors identified above are not exhaustive. We operate in a dynamic business environment in which new risks may emerge frequently. Accordingly, you should not place undue reliance on forward-looking statements, which speak only as of the dates on which they are made. In addition, results for prior periods are not necessarily indicative of results that may be expected for any future period.

Other important risk factors that could affect the outcome of the events set forth in these statements and that could affect the Company’s operating results and financial condition are discussed in Part I, Item 1A of our Annual Report on Form 10-K for the fiscal year ended December 31, 2023, as updated by our Quarterly Report on Form 10-Q for the quarter ended March 29, 2024 and as further updated by our subsequent filings with the Securities and Exchange Commission. Such statements are based on the Company’s beliefs and assumptions and on information currently available to the Company. The Company disclaims any obligation to publicly update or revise any such forward-looking statements as a result of developments occurring after the date of this document except as required by law.

In this presentation, we present the non-GAAP financial measure of Adjusted EBITDA and Adjusted Gross Profit Margin. Please see “Use of Non-GAAP Financial Measures” in the accompanying appendix and our first quarter 2024 earnings press release for the reasons why we use this measure, a reconciliation of this measure to the most directly comparable GAAP measures, and other information relating to this measure.

A Trusted, Sole-Sourced Technology Partner to Leading Global OEMs

We enable productivity improvement in healthcare and industrial markets with secular growth

APPLICATION AREAS

MEDICAL

Medical Device Technologies

- Minimally Invasive Surgery
- Surgical Robotics
- Integrated OR

Precision Medicine

- Genomics / Proteomics
- IVD
- Microscopy

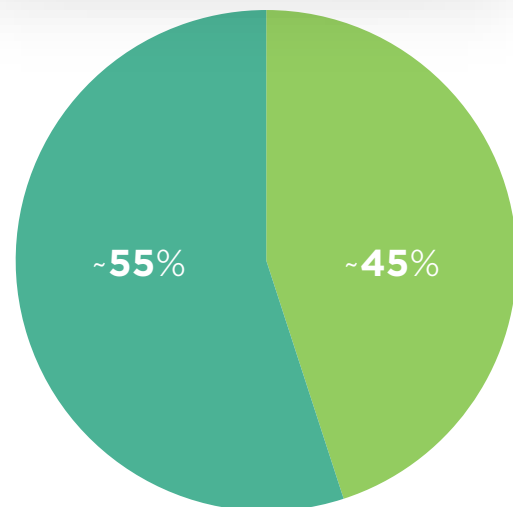

(% OF SALES)

ADVANCED INDUSTRIAL

Robotics & Automation

- Factory / Warehouse
- Unmanned Vehicles
- EV/Battery Production

Precision Manufacturing

- Micromachining
- 3D Printing / LAM
- D/EUV

BUSINESS SEGMENTS
(% OF SALES)

Robotics and Automation
~30%

Precision Medicine and Manufacturing
~30%

Medical Solutions
~40%

+\$975M

Revenue
~50% outside of the US

+\$215M

Adjusted EBITDA
+22% of sales

~\$6B

addressable market
with 5%-7% CAGR

~3,000

employees

~750

patents

Our Strategy

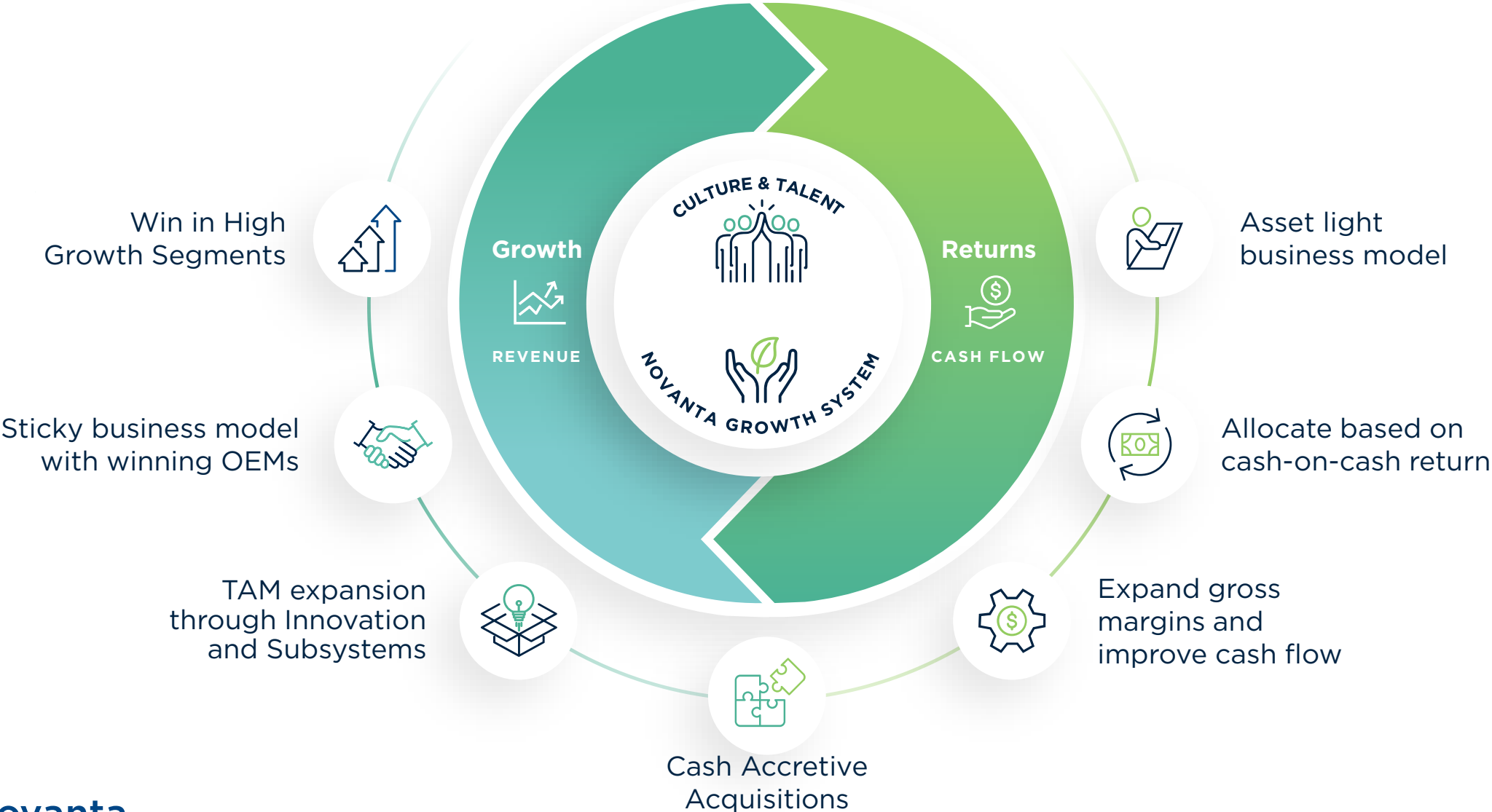

The Novanta Transformation Journey

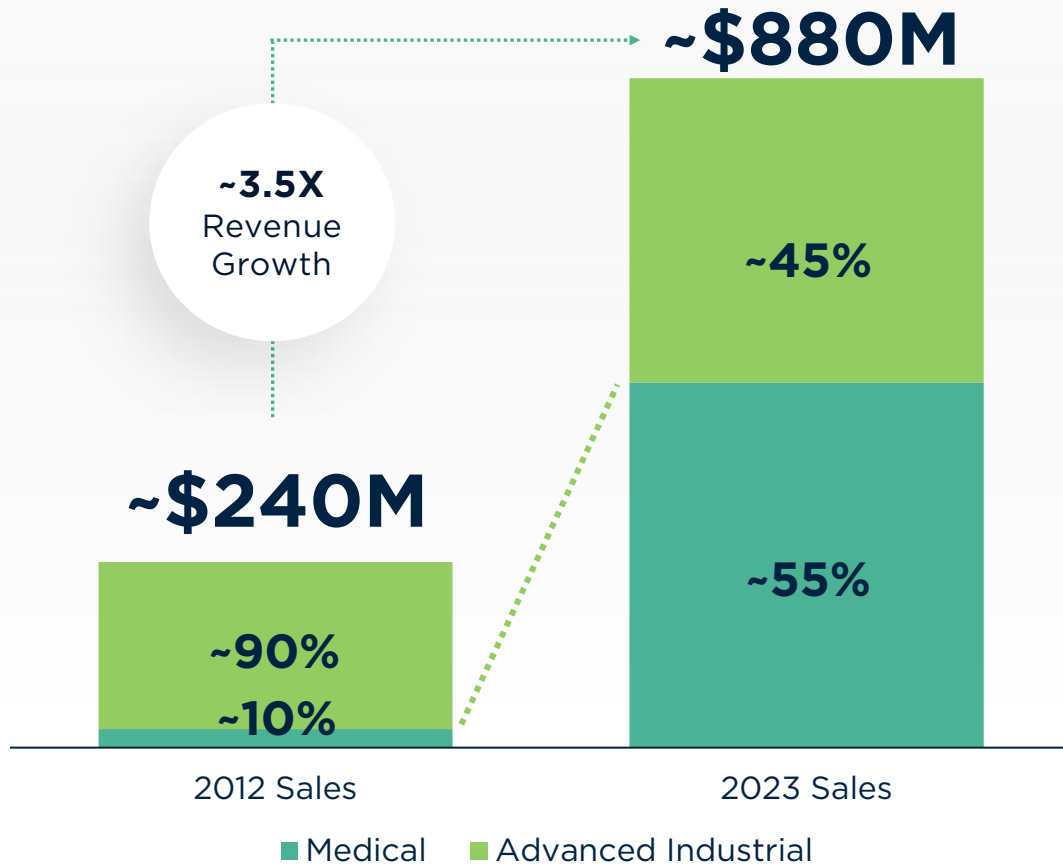

~\$1.1B
Capital deployed
for M&A

20
transactions

Vitality Index

Single
digits

Double Digit
% of sales

Subsystem Sales

Single
digits

~30% of sales

Precision Medicine and Manufacturing

SEGMENT OVERVIEW

KEY METRICS

~\$283M

REVENUE

50%

ADJUSTED GM%

7%

REVENUE CAGR SINCE 2016

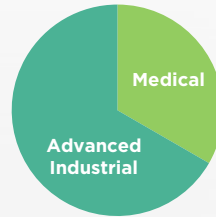

MACROECONOMIC DRIVERS

Industry 4.0

Personalized Medicine

KEY APPLICATIONS



LASER-BASED
MATERIAL
PROCESSING



DNA
SEQUENCE
DECODING



OCT
PROCEDURES



METAL-BASED
ADDITIVE
MANUFACTURING

KEY TECHNOLOGIES

SUBSYSTEMS



Optical
Light Engine



Scan Heads

COMPONENTS



Galvanometers



Drives &
Controls



CO2 Lasers



Subsystem Example: Intelligent Laser Beam Steering

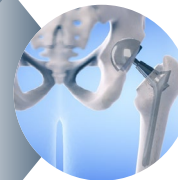
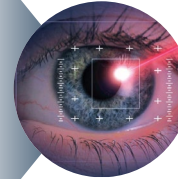
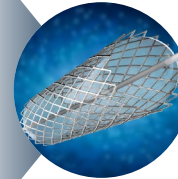

HIGH-SINGLE-DIGIT
LONG-TERM MARKET
GROWTH RATE

Never before possible
throughput, **precision**
and **miniaturization**

Increasing \$ content
and stickiness with
customers, through
intelligent subsystem
products

EXAMPLE APPLICATIONS: LASER ADDITIVE MANUFACTURING,
MICROMACHINING AND OPHTHALMOLOGY

Robotics and Automation

SEGMENT OVERVIEW

KEY METRICS

~\$273M
REVENUE

50%
ADJUSTED GM%

18%
REVENUE CAGR SINCE 2016

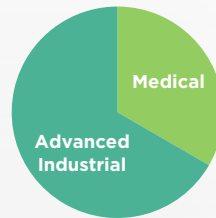

MACROECONOMIC DRIVERS

Manufacturing Automation

Penetration of Robotics

KEY APPLICATIONS



ROBOTICS AND
AUTOMATION



ROBOTIC
SURGERY



METROLOGY
AND INSPECTION



LAB
EQUIPMENT

KEY TECHNOLOGIES

SUBSYSTEMS



Robotic Joints



Mechatronics

COMPONENTS



Controls &
Drives



Precision
Motors



Robotic Tool
Changer



Inductive
Encoders



Optical
Encoders



Force / Torque
Sensor



Converging Technology Solutions for Robotic Applications

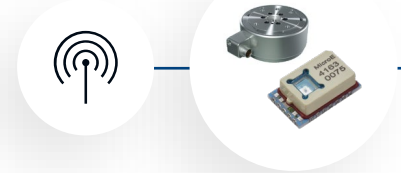

SENSING

Measuring position and providing a sense of touch

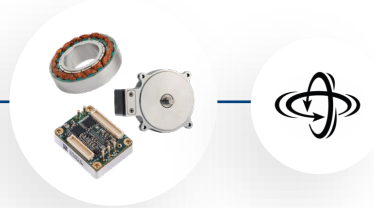
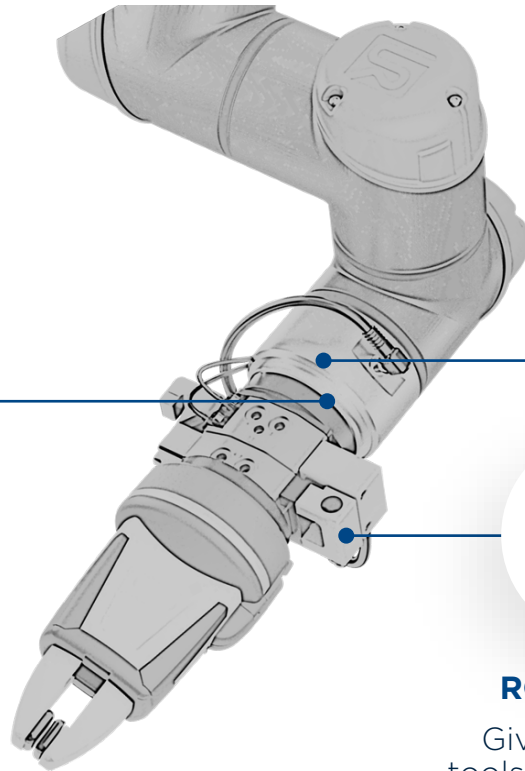

MOTION CONTROL

Precise motion via motors, drives, and mechatronics



ROBOTIC CHANGING SYSTEMS

Giving robots flexibility to change tools during the production process



DOUBLE-DIGIT

LONG-TERM MARKET GROWTH RATE

<25% PENETRATION OF ROBOTICS APPLICATIONS

Strong presence, brand recognition and value proposition

Highly engineered, end-effector technologies

Strong multi-tech integration capabilities

ROBOTICS IS A **KEY ENABLER** TO FACTORY 4.0 GOALS OF AUTOMATING TO IMPROVE SAFETY, QUALITY AND PRODUCTIVITY

Leading Technology Provider to Robotic Surgery Applications

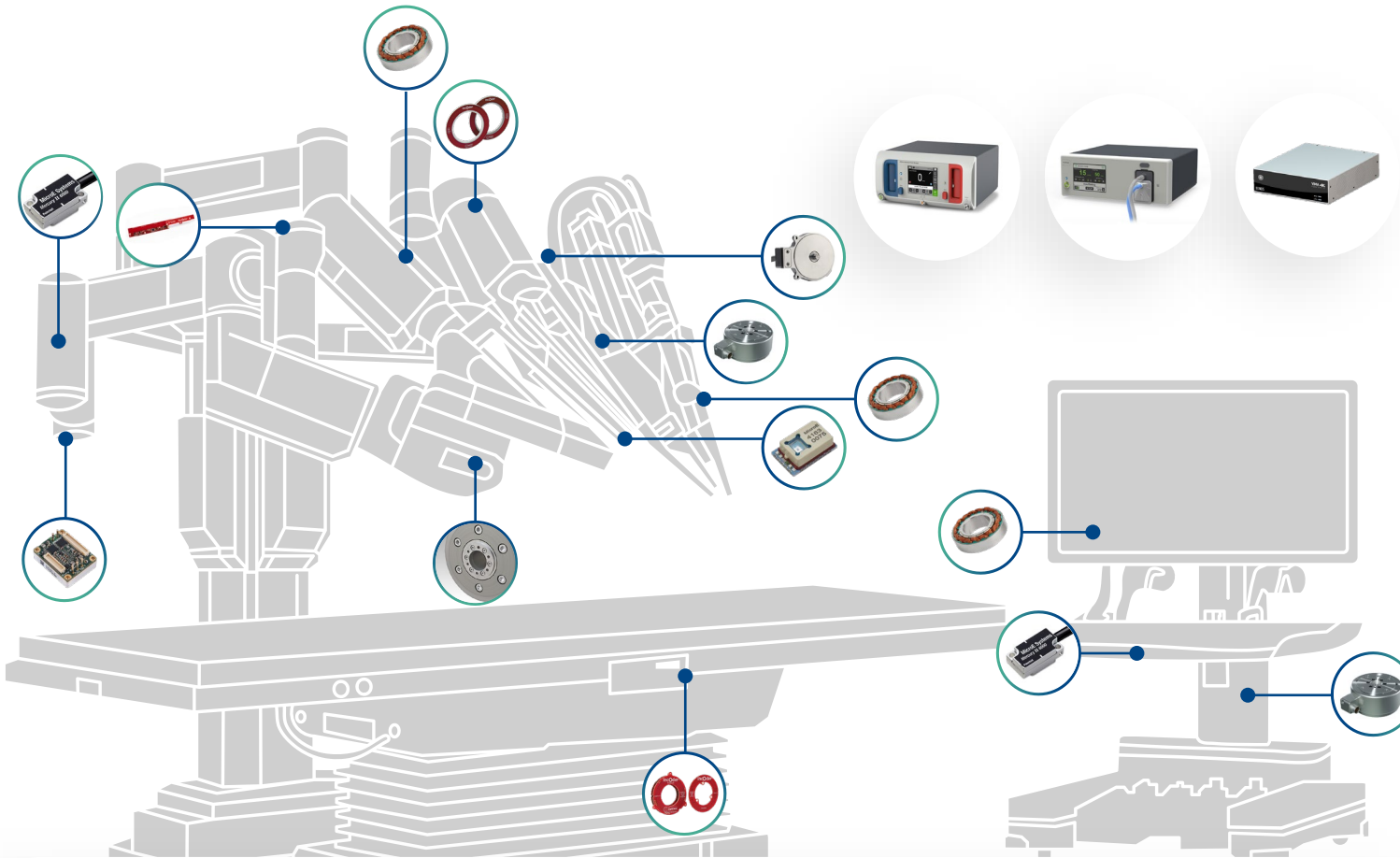

PRECISION MOTION AND FLUID / GAS MANAGEMENT SOLUTIONS FOR ROBOTIC SURGERY



DOUBLE-DIGIT
LONG-TERM MARKET
GROWTH RATE

Precision and proprietary technologies **optimized** for the most demanding applications

<5% penetration of surgical robotics applications

Medical Solutions

SEGMENT OVERVIEW

KEY METRICS

~\$325M
REVENUE

43%
ADJUSTED GM%

15%
REVENUE CAGR SINCE 2016

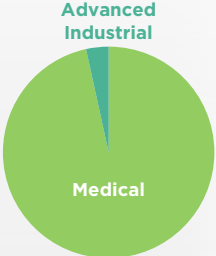

MACROECONOMIC DRIVERS

Patient Outcomes, Throughput
Hospital & Lab Productivity

KEY APPLICATIONS



MINIMALLY
INVASIVE
SURGERY



ROBOTIC
SURGERY



PRECISION
MEDICINE



PATIENT
MONITORING
EQUIPMENT



KEY TECHNOLOGIES

SUBSYSTEMS



Endoscopic
Pumps



Insufflators



iOR
Devices



Precision Motion and Advanced
Motion Control Solutions

COMPONENTS



Machine Vision
Cameras



Barcode
Scanners



RFID
Readers

Medical Growth Application: Surgical Smoke Removal

APPLICATION

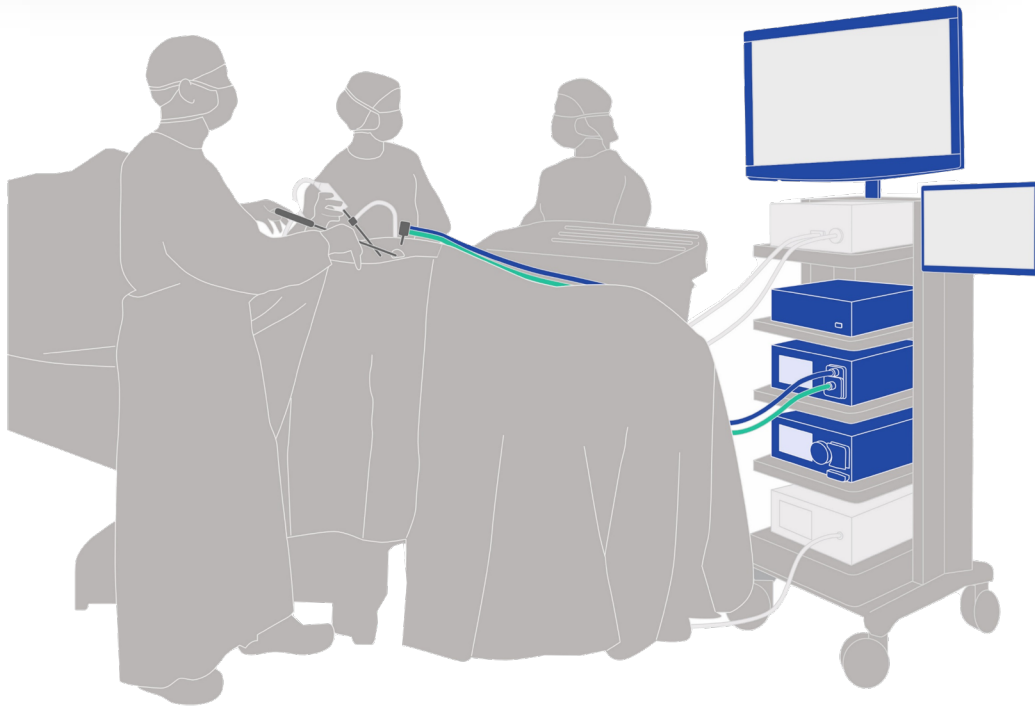

CAPABILITY

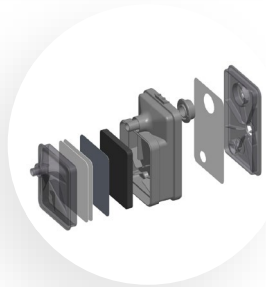

INTEGRATED INSUFFLATOR WITH SMOKE EVACUATION



DOUBLE-DIGIT
LONG-TERM MARKET
GROWTH RATE

High growth medical
market opportunity,
estimated at **20%**
per year

Integrated smoke
evacuation increases
safety, optimizes
workflow and
eliminates separate
equipment

Intelligent Solutions for Precision Medicine Applications



HIGH-SINGLE-DIGIT
LONG-TERM MARKET GROWTH RATE

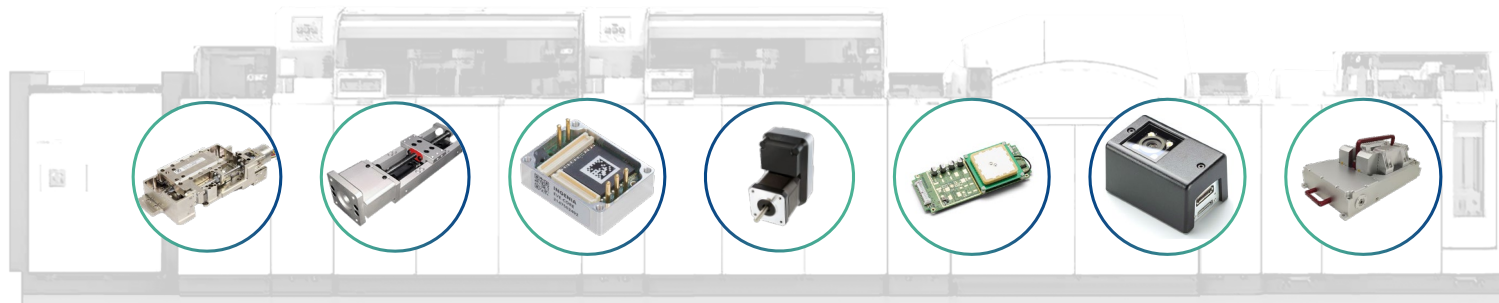

PRECISION MOTION
(sample movement and alignment)



RFID READER
(reagent & sample tracking)



MACHINE VISION
(sample scanning and analysis)



LIGHT ENGINE SUB-SYSTEM
(DNA sequencing)

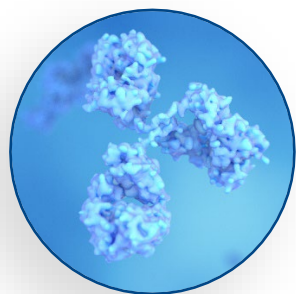

Proteomics

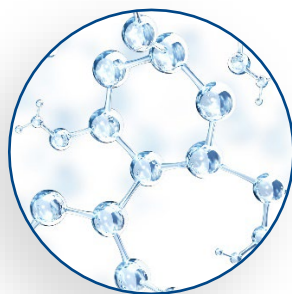

Spatial Biology



Genomics



Lab Automation

Enabling **automation** and **cutting-edge capabilities** for precision medicine equipment

Transform disease research, drug discovery, and clinical development

Supporting clinical adoption of high-throughput DNA sequencing

HOW WE OPERATE

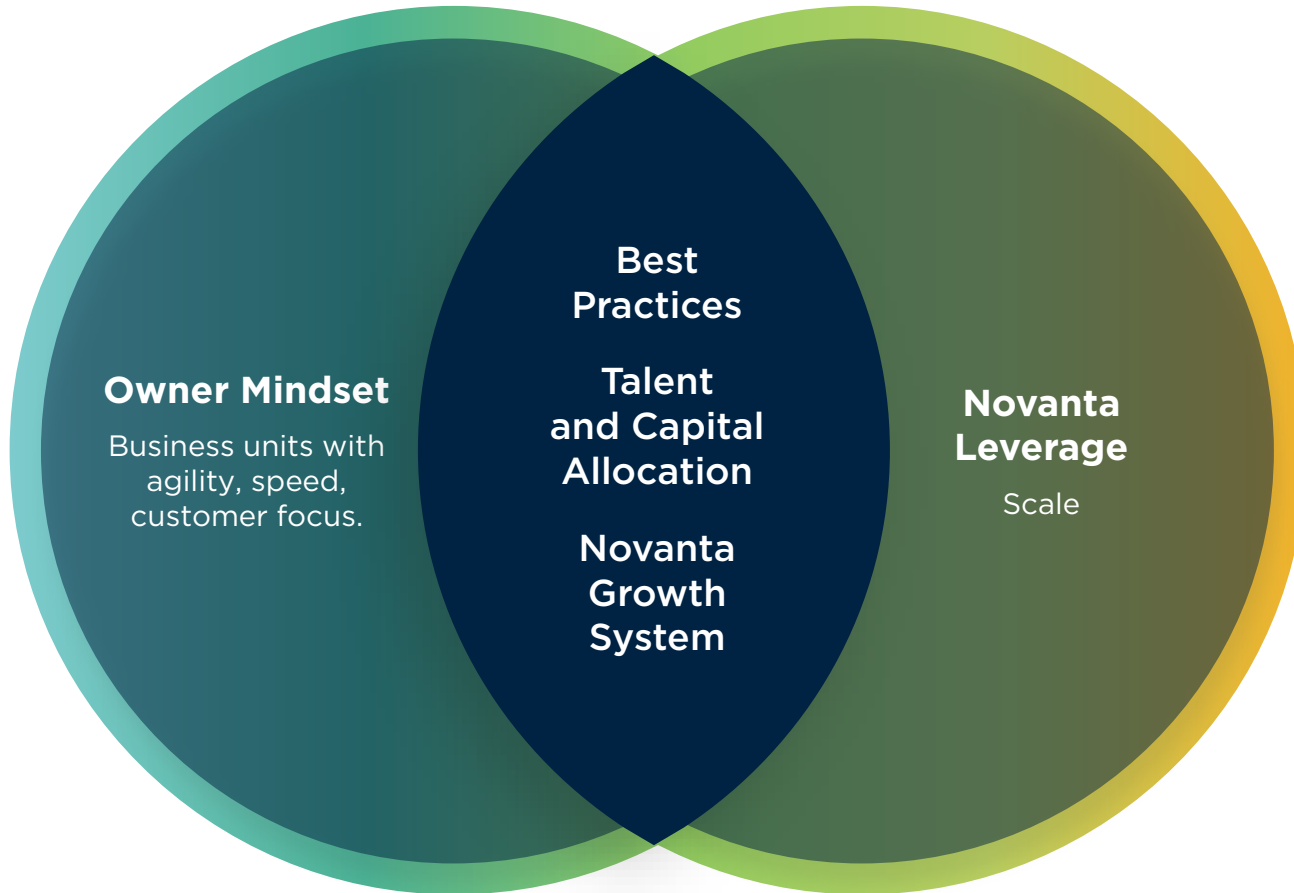

OUR COLLABORATIVE PERFORMANCE CULTURE IS OUR COMPETITIVE ADVANTAGE

COHESIVE TEAMS

Diverse, inclusive, collaborative: committed to win

ENGAGED EMPLOYEES

Engage around a shared vision and purpose



NOVANTA VALUES

What we stand for and how we behave

NOVANTA GROWTH SYSTEM

Tools and processes for continuous improvement

Delivering Consistent Financial Results

REVENUE

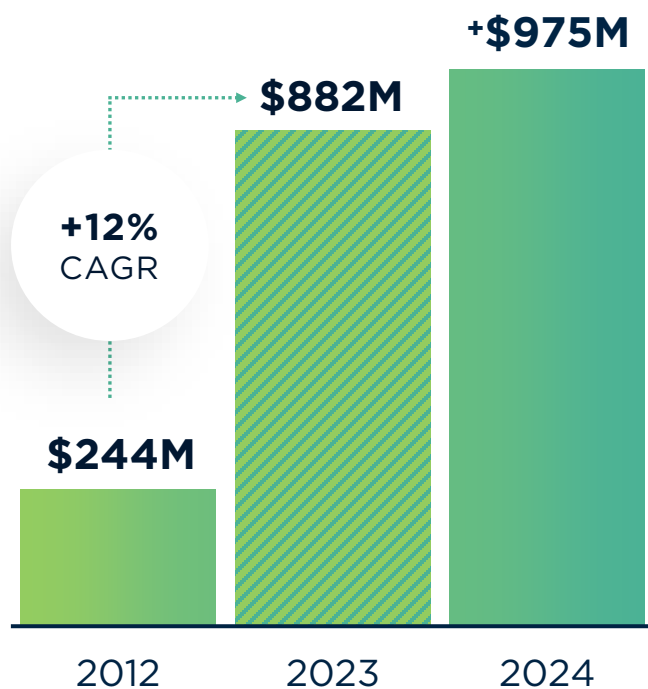

ADJUSTED EBITDA

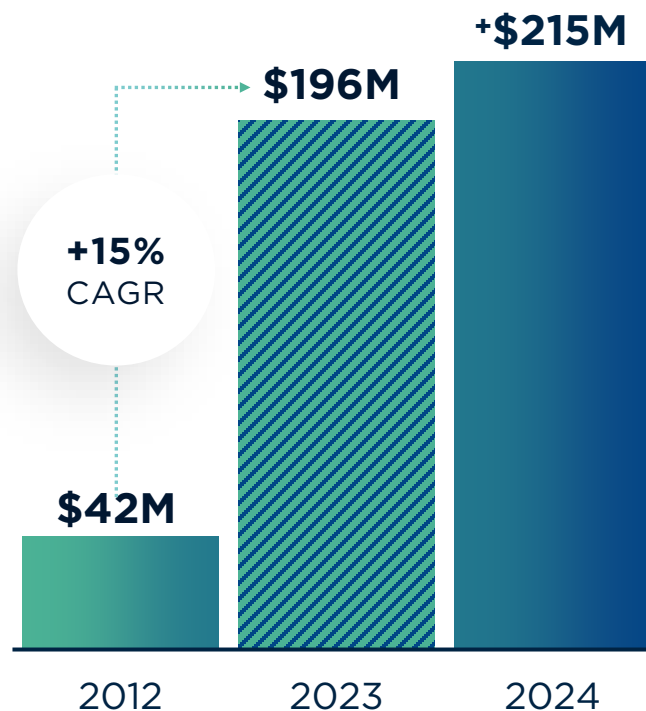

FINANCIAL FRAMEWORK

Mid to high single-digit **organic growth**

Double-digit reported growth **through acquisitions**

100 bps per year of **gross margin expansion**

Strong **free cash flow** generation

Delivering Innovation

Where It Matters Most

Medical Device Technologies

Robotics and Automation

Precision Medicine

Precision Manufacturing

Environment, Sustainability and Governance

NOVANTA ESG TARGETS

1

Long-term goal to achieve **net zero** greenhouse gas (GHG) emissions by 2050

2

Provide employees with **one day of paid time-off** (PTO) to volunteer at an approved non-profit organization

3

Expand **Diversity, Equity, and Inclusion** (DEI) efforts

4

Integrate **sustainability criteria** in purchasing

5

Expand relevant ISO certification to **all applicable facilities**, including ISO 14001

MADE SOLID PROGRESS TOWARDS ALL LONG-TERM GOALS, AND MET OR EXCEEDED OUR SHORT-TERM OBJECTIVES FOR 2023

REPORTING ACCORDING TO SASB AND TCFD STANDARDS



2023 ESG Report is published on [Novanta.com](https://www.novanta.com)

Use of Non-GAAP Measures

The non-GAAP financial measures used in this presentation are Adjusted EBITDA and Adjusted Gross Profit Margin.

The Company believes that these non-GAAP financial measures provide useful and supplementary information to investors regarding the operating performance of the Company. It is management's belief that these non-GAAP financial measures would be particularly useful to investors because of the significant changes that have occurred outside of the Company's day-to-day business in accordance with the execution of the Company's strategy. This strategy includes streamlining the Company's existing operations through site and functional consolidations, strategic divestitures and product line closures, expanding the Company's business through significant internal investments, and broadening the Company's product and service offerings through acquisitions of innovative and complementary technologies and solutions. The financial impact of certain elements of these activities, particularly acquisitions, divestitures, and site and functional restructurings, is often large relative to the Company's overall financial performance and can adversely affect the comparability of its operating results and investors' ability to analyze the business from period to period.

The Company defines Adjusted EBITDA as operating income (loss) from continuing operations before deducting depreciation, amortization, non-cash share-based compensation, costs directly related to employee COVID-19 testing, restructuring, acquisition, divestiture and other costs, impairment of goodwill and intangible assets, acquisition fair value adjustments, CEO transition costs, and inventory related charges associated with product line closures.

The calculation of Adjusted Gross Profit Margin excludes amortization of acquired intangible assets and inventory fair value adjustments related to business acquisitions because: (i) the amounts are non-cash; (ii) the Company cannot influence the timing and amount of future expense recognition; and (iii) excluding such expenses provides investors and management better visibility into the underlying trends and performance of our businesses.

The Company's Adjusted EBITDA and Adjusted Gross Margin are used by management to evaluate operating performance, communicate financial results to the Board of Directors, benchmark results against historical performance and the performance of peers, and evaluate investment opportunities, including acquisitions and divestitures. In addition, Adjusted EBITDA and Adjusted Gross Margin are financial performance metrics used to determine incentive compensation payments for senior management and employees. Accordingly, the Company believes that this non-GAAP financial measure provides greater transparency and insight into management's method of analysis.

Non-GAAP financial measures should not be considered as substitutes for, or superior to, measures of financial performance prepared in accordance with GAAP. They are limited in value because they exclude charges that have a material effect on the Company's reported results and, therefore, should not be relied upon as the sole financial measures to evaluate the Company's financial results. The non-GAAP financial measures are meant to supplement, and to be viewed in conjunction with, GAAP financial measures. Investors are encouraged to review the reconciliation of these non-GAAP financial measures to their most directly comparable GAAP financial measures as provided in the tables accompanying this document.

Novanta provides earnings guidance on a non-GAAP basis and does not provide earnings guidance on a GAAP basis, with the exception of GAAP revenue guidance. A reconciliation of the Company's forward-looking Adjusted EBITDA guidance to the most directly comparable GAAP financial measures is not provided because of the inherent difficulty in forecasting and quantifying certain amounts that are necessary for such reconciliations, including acquisitions and related expenses; impact of purchase price allocations for recently completed acquisitions; future changes in the fair value of contingent considerations; future restructuring expenses; foreign exchange gains/(losses); significant discrete income tax expenses (benefits); benefits or expenses associated with the completion of tax audits; divestitures and related expenses; gains and losses from sale of real estate assets; costs related to product line closures; intangible asset impairment charges and related asset write-offs; and other charges reflected in the Company's reconciliation of historical non-GAAP financial measures, the amounts of which, based on past experience, could be material.

Non-GAAP Reconciliation

(in thousands of dollars)

	TWELVE MONTHS ENDED												THREE MONTHS ENDED
	Dec 31, 2012	Dec 31, 2013	Dec 31, 2014	Dec 31, 2015	Dec 31, 2016	Dec 31, 2017	Dec 31, 2018	Dec 31, 2019	Dec 31, 2020	Dec31, 2021	Dec 31, 2022	Dec. 31, 2023	Mar 29, 2024
REVENUE													
Revenue (GAAP)	\$243,796	\$316,910	\$364,706	\$373,598	\$384,758	\$521,290	\$614,337	\$626,099	\$590,623	\$706,793	\$860,903	\$881,662	\$230,916
ADJUSTED EBITDA													
Operating income (loss) from continuing operations (GAAP)	\$20,798	\$19,951	(\$16,729)	\$29,304	\$32,955	\$57,566	\$71,013	\$55,282	\$55,888	\$64,054	\$103,079	\$110,496	\$25,607
Depreciation and amortization	12,458	19,570	23,797	19,114	20,357	30,758	37,052	38,280	38,293	43,126	53,158	46,612	12,929
Share-based compensation	4,534	5,442	4,329	4,387	4,293	5,493	7,647	9,340	22,535	22,557	23,108	25,588	6,077
Impairment of goodwill and intangible assets	-	-	41,442	-	-	-	-	-	-	-	-	-	-
Restructuring, acquisition, divestiture and other costs	4,369	5,387	3,091	8,273	7,945	7,542	8,041	16,574	3,810	18,020	4,384	13,060	2,298
Inventory related charges associated with product line closures	-	-	-	-	1,370	-	-	-	-	-	-	473	-
Acquisition fair value adjustments	-	965	596	358	205	4,754	-	1,270	188	1,411	160	-	2,777
CEO transition costs	-	-	-	-	1,306	-	-	-	-	-	-	-	-
Employee COVID-19 testing costs	-	-	-	-	-	-	-	-	275	3,568	240	-	-
Adjusted EBITDA (Non-GAAP)	\$42,159	\$51,315	\$56,526	\$61,436	\$68,431	\$106,113	\$123,753	\$120,746	\$120,989	\$152,736	\$184,129	\$196,229	\$49,688