

# CORPORATE OVERVIEW

July 25, 2024

WE MAKE  
**WHAT'S NEXT**  
POSSIBLE

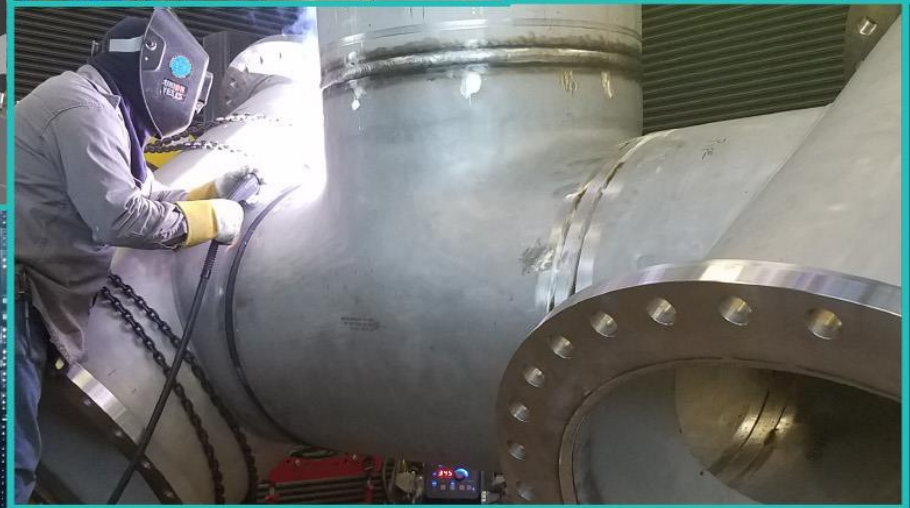
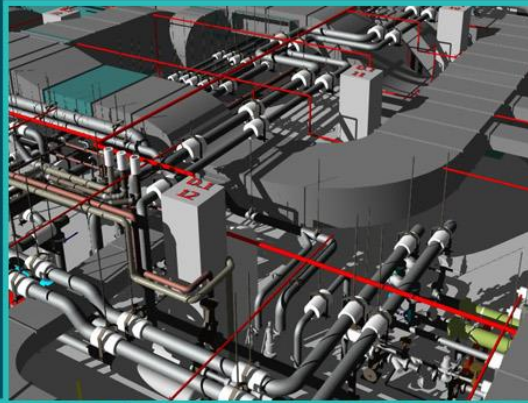

# FORWARD-LOOKING STATEMENTS AND NON-GAAP FINANCIAL DISCLOSURES

## **Forward-Looking Statements**

*This presentation and related materials contain forward-looking statements. Such statements speak only as of the date on the cover of this slide deck, and EMCOR assumes no obligation to update any such forward-looking statements, unless required by law. These forward-looking statements may include statements regarding anticipated future operating and financial performance; the nature and impact of our remaining performance obligations and timing of future projects; our ability to be prudent capital allocators; our anticipated investments in our business; our ability to pursue organic and strategic investments and acquisitions; our ability to return capital to shareholders, including through share repurchases and dividends; market opportunities; market growth prospects and demand trends; customer trends; project mix; and our energy and emissions goals, including our 2035 goals. These forward-looking statements involve risks and uncertainties that could cause actual results to differ materially from those anticipated (whether expressly or implied) by the forward-looking statements. Accordingly, these statements do not guarantee future performance or events. Applicable risks and uncertainties include, but are not limited to, adverse effects of general economic conditions; climate change and related environmental issues; market or regulatory responses to climate change; domestic and international political developments; changes in the specific markets for EMCOR's services; adverse business conditions, including labor market tightness and/or disruption, productivity challenges, the impact of claims and litigation, the nature and extent of supply chain disruptions impacting availability and pricing of materials, global conflicts, and inflationary trends more generally, including fluctuations in energy costs; the impact of legislation and/or government regulations; changes in interest rates; the availability of adequate levels of surety bonding; increased competition; and unfavorable developments in the mix of our business. Certain of the risk factors associated with EMCOR's business are also discussed in Part I, Item 1A "Risk Factors," of the Company's 2023 Form 10-K, and in other reports filed from time to time with the Securities and Exchange Commission and available at [www.sec.gov](http://www.sec.gov) and [www.emcorgroup.com](http://www.emcorgroup.com). Such risk factors should be taken into account in evaluating our business, including any forward-looking statements.*

## **Non-GAAP Measures**

*Information conveyed with this presentation may contain certain financial measures that were not prepared in accordance with U.S. generally accepted accounting principles (GAAP). The Company uses these non-GAAP measures as key performance indicators for the purpose of evaluating performance internally. We also believe that these non-GAAP measures provide investors with useful information with respect to our ongoing operations. Any non-GAAP financial measures presented are not, and should not be viewed as, substitutes for financial measures required by GAAP, have no standardized meaning prescribed by GAAP, and may not be comparable to the calculation of similar measures of other companies.*

## KEY TAKEAWAYS

**1** EMCOR installs, services, operates, maintains, and protects ***complex and dynamic systems and critical infrastructure for facilities in multiple growth sectors of the economy***

**2** Expertise in ***managing highly skilled trade labor performing complex installations and service*** across mechanical, electrical, air conditioning, heating, fire protection, lighting, security, and power generation systems

**3** Operates at the ***intersection of long-term megatrends and sectors benefiting from private investment and government incentives***, including energy transition and expansion; sustainability and efficiency; and reshoring and nearshoring

**4** ***Resilient and flexible business model*** with proven ability to pivot to diverse, high-growth sectors such as data centers, semiconductors, healthcare, life sciences, and EV value chain

**5** ***Mission First, People Always*** commitment drives our ability to attract, invest in, and retain talent, while prioritizing the health and safety of our workforce

**6** Track record of disciplined execution has resulted in ***strong operating cash flow generation and a liquid balance sheet*** that supports a balanced capital allocation strategy and makes us a valued business partner on large, complex projects

## EMCOR AT A GLANCE

- » A Fortune 500® company, EMCOR Group, Inc. (NYSE: EME) is a leader in mechanical and electrical construction, industrial and energy infrastructure, and building services
- » Service offerings specialize in the planning, installation, operation, maintenance, and protection of sophisticated and dynamic systems and critical infrastructure in facilities, including:



Mechanical



Electrical



Air Conditioning



Lighting



Heating



Security



Fire Protection



Power Generation

- » EMCOR companies serve a diverse range of non-residential sectors across most parts of the economy
- » Benefitting from multiple trends across data centers and connectivity; energy transition and expansion; efficiency and sustainability; and reshoring and nearshoring, many benefitting from government incentives

### Key Highlights

**\$12.6B**  
2023  
Revenue

**\$3.7B**  
2Q 2024  
Revenue

**\$9.0B**  
RPOs<sup>1</sup>

**~40,000**<sup>1</sup>  
Employees

**103%**  
Operating Cash  
Flow Conversion<sup>2,3</sup>

**~80M**  
Hours Worked<sup>3</sup>

1. As of 6/30/24

2. Operating cash flow conversion defined as operating cash flow / operating income

3. For the twelve-month period ended 12/31/23

# BROAD CONSTRUCTION AND SERVICES PLATFORM

## Construction Services

Mechanical

Electrical

Mechanical and electrical contractors with decades of experience in multiple U.S. sectors

**~63%**  
of 2023 Revenue

### Selected Areas of Expertise



HVAC



High / Low  
Voltage



Fire  
Protection



Lighting and  
Control Systems



Plumbing

## Building Services

U.S.

U.K.

Provider of mechanical services and construction, site-based facility management and maintenance, and energy efficiency services

**~28%**  
of 2023 Revenue

### Selected Areas of Expertise



Building Control  
Systems



Retrofit  
Projects



Energy Conservation  
and Efficiency



IAQ  
Services



HVAC  
Services

## Industrial Services

Provider of process turnaround services in North America

**~9%**  
of 2023 Revenue

### Selected Areas of Expertise



Heat Exchanger  
Services / Fabrication



Renewable  
Energy and Solar



Turnaround  
Services



Specialty  
Welding

# WELL-POSITIONED TO BENEFIT FROM MULTIPLE TRENDS DRIVING PROFITABLE ORGANIC GROWTH

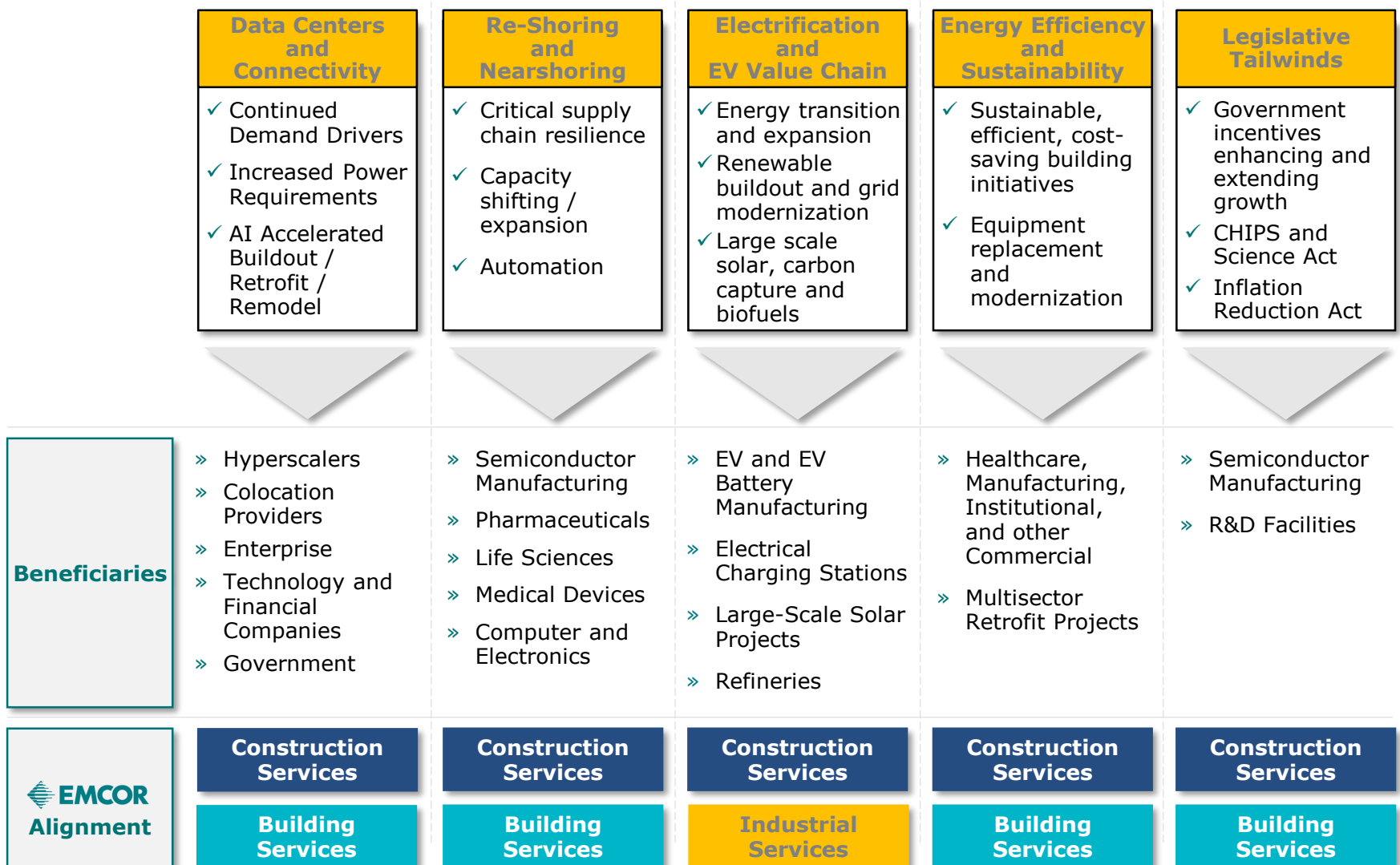

# WELL-POSITIONED TO BENEFIT FROM EXPECTED ENERGY EFFICIENCY AND SUSTAINABILITY TRENDS

- » Strong demand expected in HVAC and lighting retrofit, building automation and control services that improve building efficiency, energy consumption, and indoor air quality (IAQ)
- » Variety of sectors include traditional and high-tech manufacturing, institutional, healthcare, and commercial
- » EMCOR's Mechanical Services division, within its Building Services segment, offers project and retrofit design and installation, as well as repair and maintenance services



## U.S. Building Services

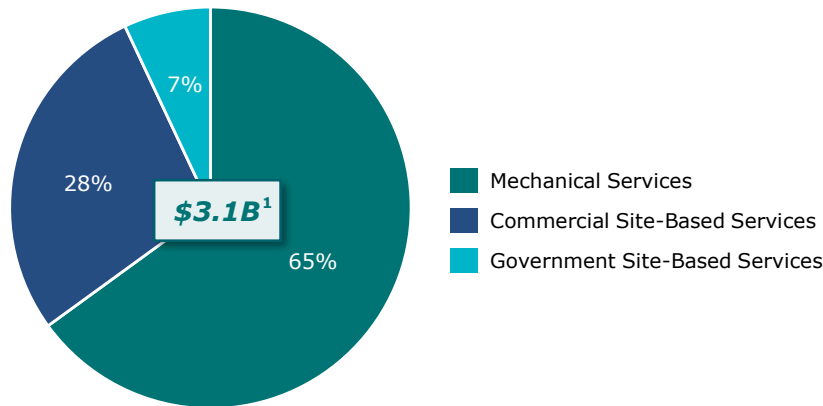

## Mechanical Services

~2,500 HVAC Technicians

~450 Controls Technicians

~350 Energy Engineers (LEED)

~4,000 Vehicles on Road Daily

# EMCOR'S DIVERSE BUSINESS MIX

## Broad Construction and Services Platform

**2023 Revenue By Segment**

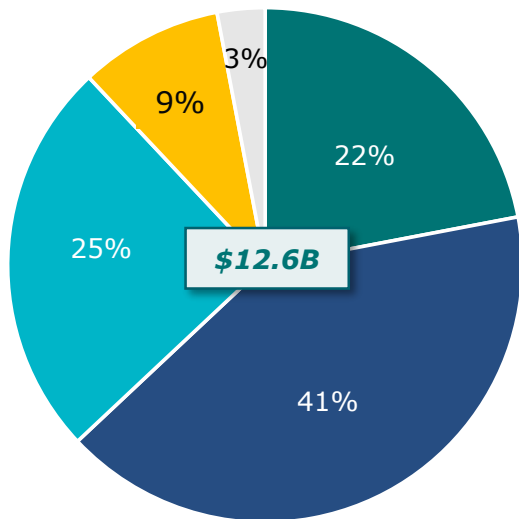

- Electrical Construction
- Mechanical Construction
- Building Services
- Industrial Services
- UK Building Services

## Diverse Remaining Performance Obligations (RPOs) by Sector

(\$ Millions) (Unaudited)

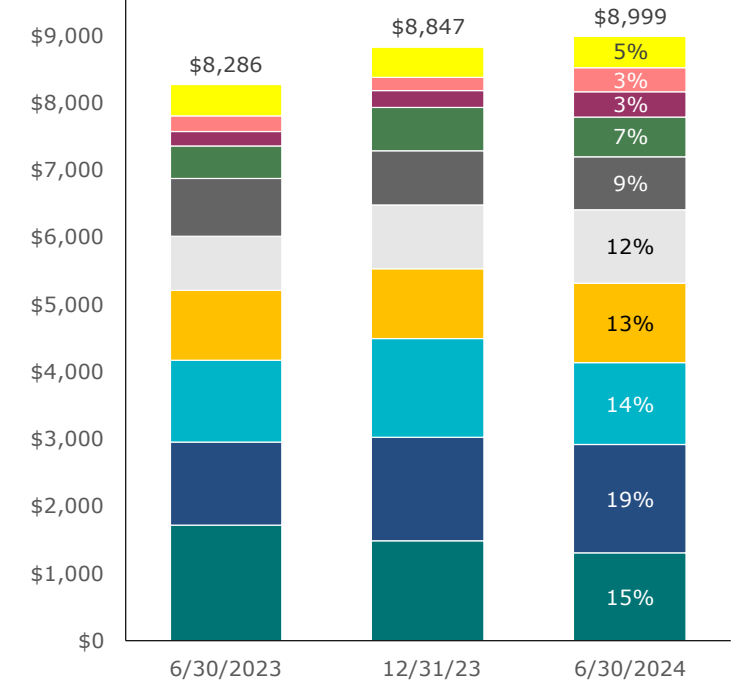

- Commercial
- Network and Communications
- High-Tech Manufacturing
- Healthcare
- Institutional
- Manufacturing and Industrial
- Water and Wastewater
- Transportation
- Hospitality and Entertainment
- Short Duration Projects



# PARTICIPATING IN DIVERSE AND RESILIENT SECTORS

## Diverse Remaining Performance Obligations (RPOs)

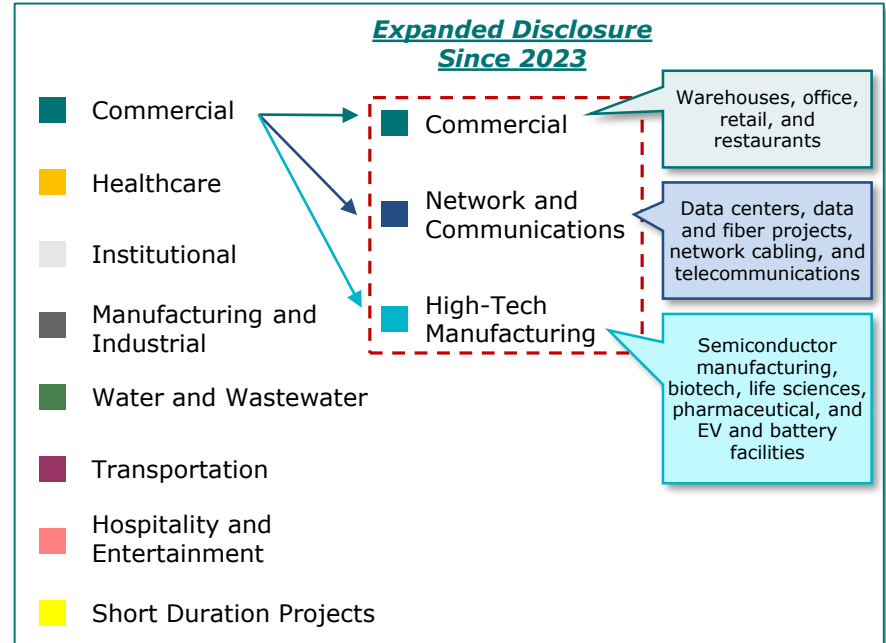
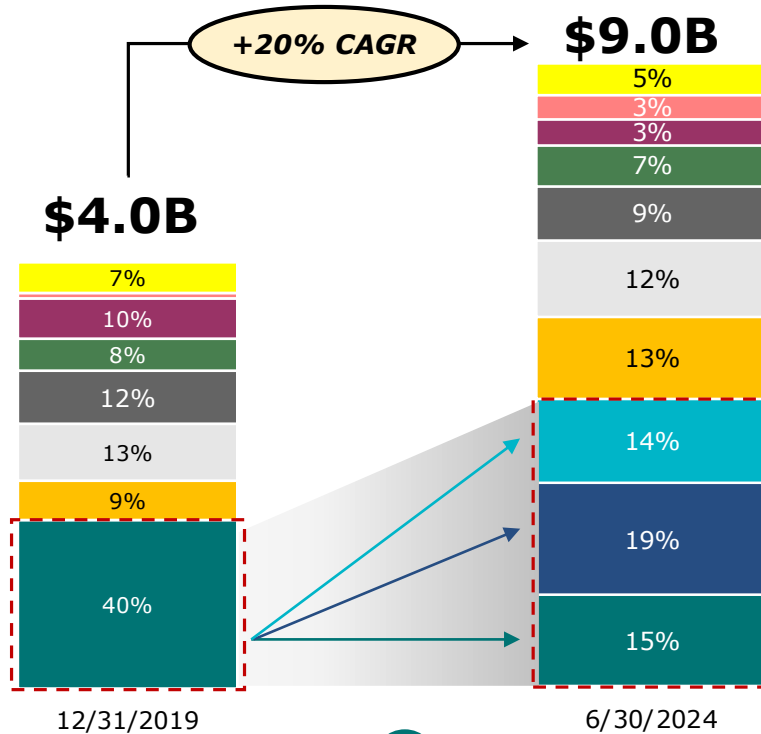

✓ **Proven ability to pivot business and workforce to enhance exposure to resilient and growing sectors**

✓ **Expanded sector disclosure, breaking out Network and Communications and High-Tech Manufacturing from Commercial**

✓ **Limited exposure to new office construction projects**

✓ **RPOs at near record levels, along with a robust pipeline, continue to provide solid line of sight for the remainder of 2024**

# LOCAL EXECUTION, NATIONAL REACH

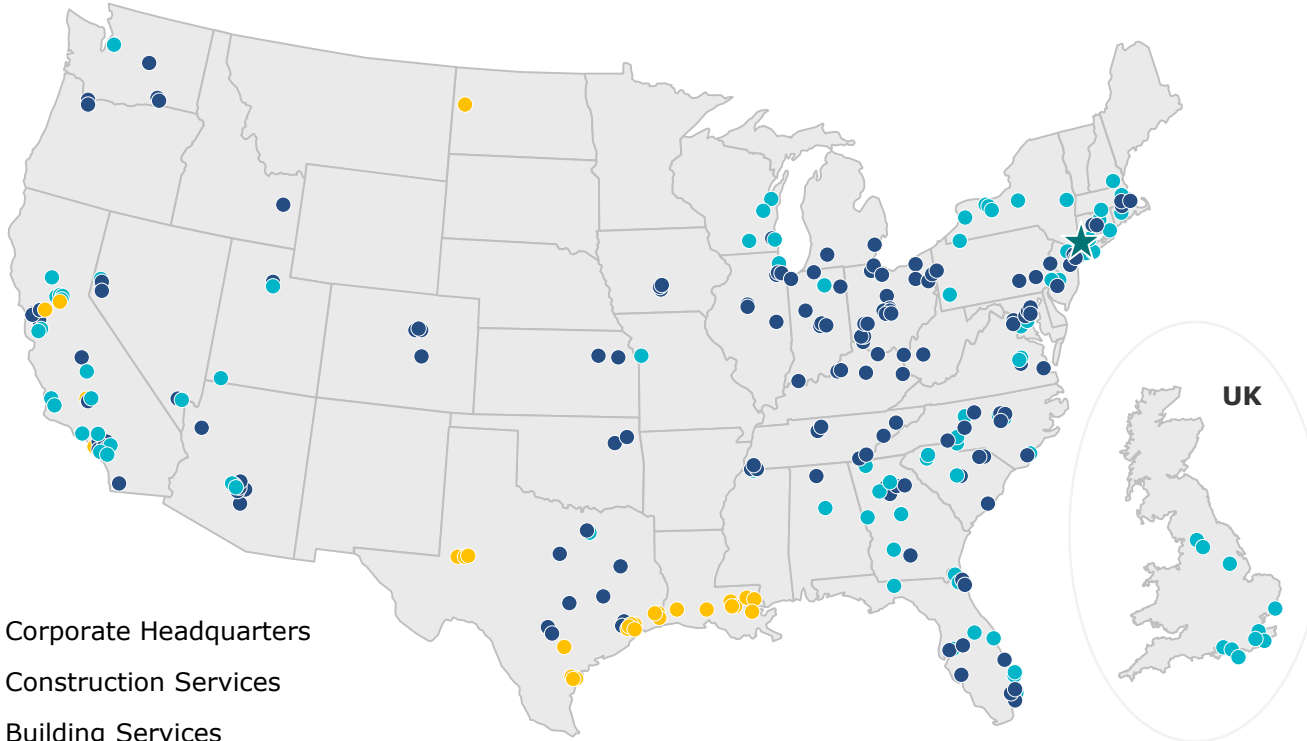

- ★ Corporate Headquarters
- Construction Services
- Building Services
- Industrial Services

**Strategic Locations  
in Key  
Geographies**

**~400**  
U.S. Locations

**~100**  
Operating Subsidiaries

## Select Subsidiaries

### Construction Services

- ◆ **Batchelor & Kimball**  
An EMCOR Company
- ◆ **DeBra-Kuempel**  
An EMCOR Company
- ◆ **Dynalectric**  
An EMCOR Company
- ◆ **F&G Mechanical**  
An EMCOR Company
- ◆ **Forest Electric**  
An EMCOR Company
- ◆ **Gibson**  
An EMCOR Company
- ◆ **J.C. Higgins**  
An EMCOR Company
- ◆ **Penguin**  
An EMCOR Company
- ◆ **Poole and Kent**  
An EMCOR Company
- ◆ **S.A. Comunale**  
An EMCOR Company
- ◆ **Shambaugh**  
An EMCOR Company
- ◆ **Southern Industrial Constructors**  
An EMCOR Company
- ◆ **University Mechanical & Engineering Contractors**  
An EMCOR Company
- ◆ **Wasatch Electric**  
An EMCOR Company

### Building Services

- ◆ **EMCOR Services**  
Mesa Energy
- ◆ **EMCOR Services**  
New England Mechanical
- ◆ **EMCOR Services**  
Hill York
- ◆ **EMCOR Services**  
Newcomb and Company
- ◆ **EMCOR Services**  
Northeast

### Industrial Services

- ◆ **AltairStrickland**  
An EMCOR Industrial Services Company
- ◆ **Ohmstede**  
An EMCOR Industrial Services Company
- ◆ **Performance Mechanical, Inc.**  
An EMCOR Industrial Services Company
- ◆ **REPCON**  
An EMCOR Industrial Services Company



## WHY EMCOR WINS

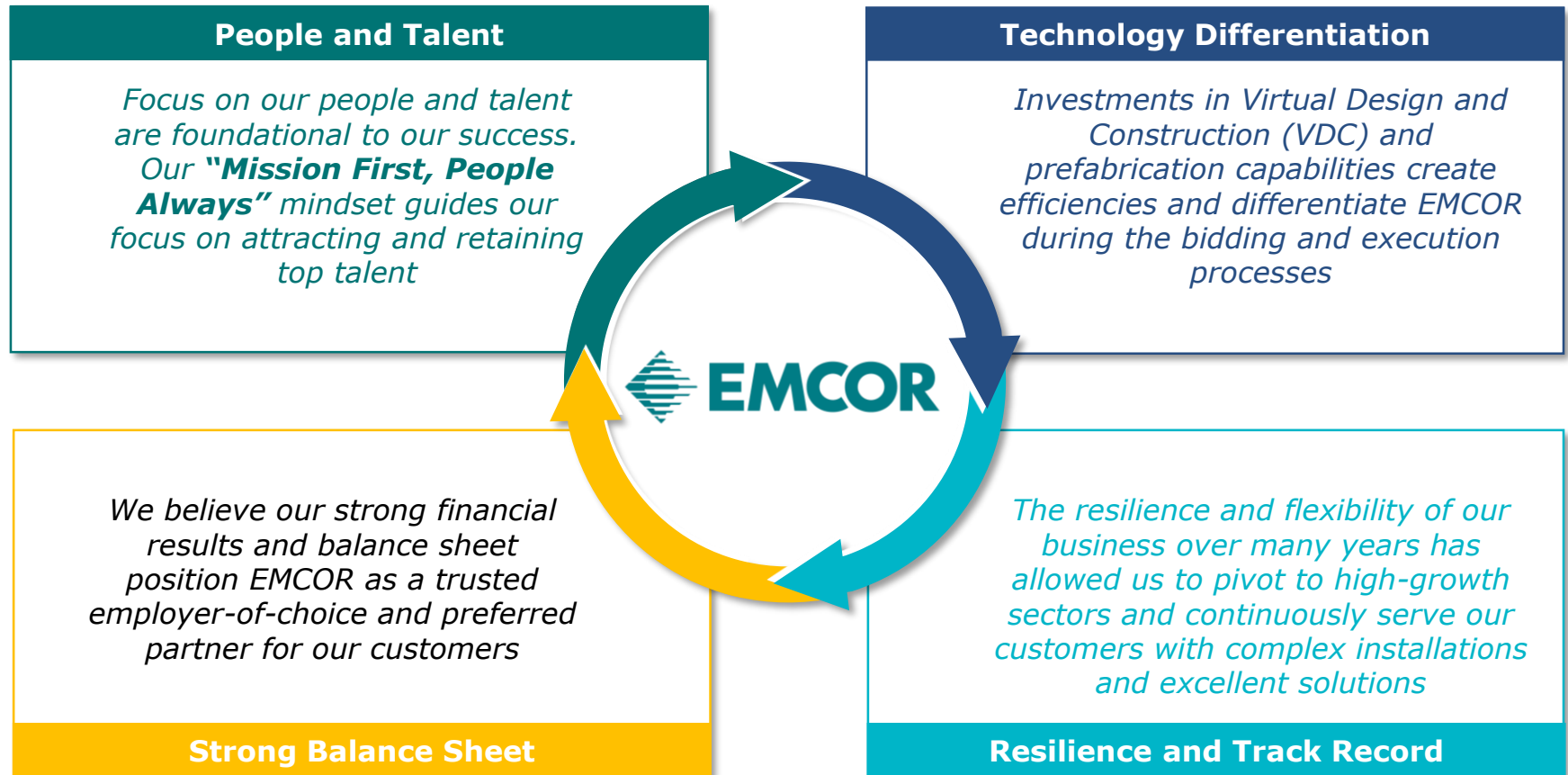

# LEADER IN VIRTUAL DESIGN AND CONSTRUCTION AND PREFABRICATION

## Virtual Design and Construction (VDC)

- » One of the most essential digital tools available to specialty contractors today
- » EMCOR companies across the country leverage VDC technologies, including BIM, to design, build, and coordinate complex electrical and mechanical projects of all types

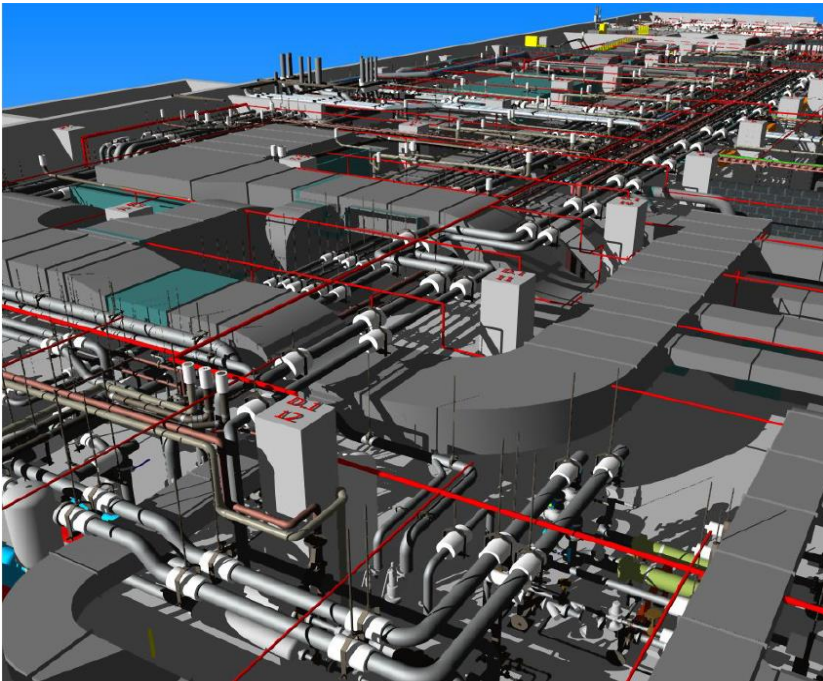

## Prefabrication

- » Leveraging VDC and BIM, EMCOR companies utilize prefabrication in their construction processes, offering customized electrical, sheet metal, fire sprinkler, and piping fabrication
- » Many of our companies maintain state-of-the-art shops across the country, totaling thousands of square feet of fabrication and warehouse space



# MISSION FIRST, PEOPLE ALWAYS CULTURE GUIDES OUR STRATEGY AND OPERATIONS

## Our People

- » Foundational focus on our workforce and culture that values **integrity, discipline, transparency, mutual respect and trust, commitment to safety, and teamwork**
- » Striving for a zero-injury environment and culture across our operating subsidiaries
- » Industry leading TRIR – less than half the industry average for the 15<sup>th</sup> consecutive year
- » **Our commitment to safety and investment in talent make EMCOR an employer-of-choice**

## Sustainability

- » **We are committed to strong sustainability practices and strive to be transparent on these initiatives**, in-line with our shareholders' expectations
- » Our sustainability reporting **is guided by the Sustainability Accounting Standards Board (SASB) standard** for the Engineering and Construction Services industry
- » Incorporated guidance from the recommendations of the Task Force on Climate-Related Financial Disclosures (TCFD) to disclose scope 1, 2 and 3 greenhouse gas emissions and set forward-looking reduction goals for scope 1 and 2

### TOTAL HOURS WORKED

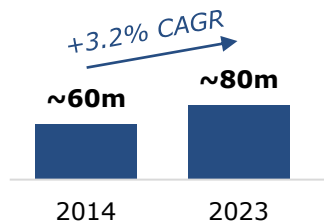

### TOTAL RECORDABLE INCIDENT RATE (TRIR)

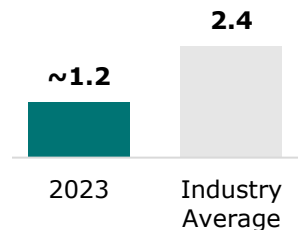

### 2035 ENERGY AND EMISSIONS GOALS

**30 – 40%**

Per capita reduction in carbon-based fuel consumption across service fleet

**20%**

Reduction in per capita Scope 1 and 2 GhG output

# COMMITMENT TO BALANCED CAPITAL ALLOCATION

### Capital Allocation Strategy

**Business Reinvestment**

**Capex**

- » Expand prefabrication capacity
- » Investments in VDC technologies, including BIM, automation, and robotics

**M&A**

- » Augment business with complimentary service offerings, bolster capabilities, service additional geographies
- » Ongoing evaluation of diverse pipeline, both tuck-in and targets of scale

**Shareholder Return**

**Share Repurchases**

- » Track record of proven return of capital to shareholders
- » ~\$611 million remaining on share repurchase authorization\*

**Dividends**

- » Steady, progressive dividend policy
- » In 2024, increased quarterly dividend by 39% to \$0.25 / share

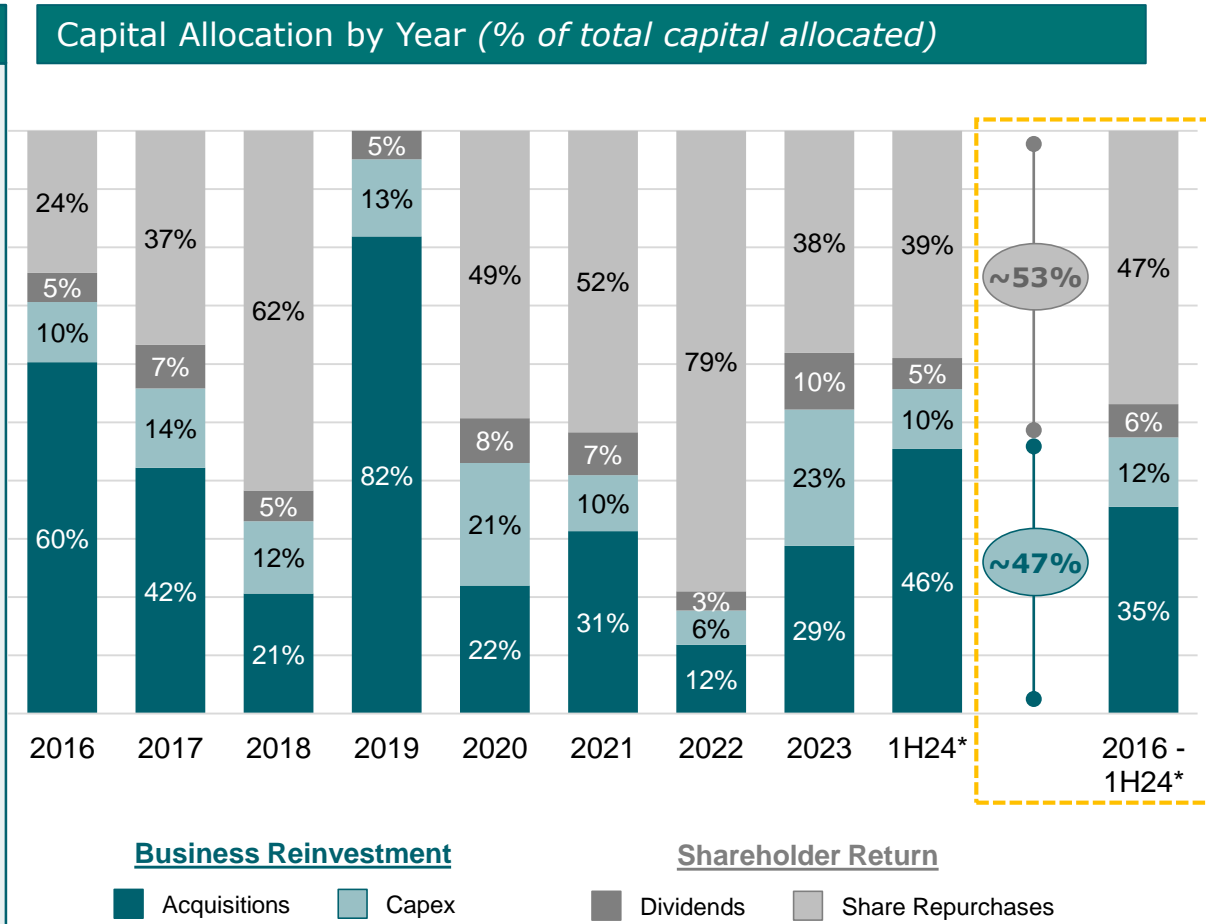

***Strong balance sheet and long-term cash flow generation support strategic and balanced approach to capital deployment***

\* As of 6/30/24

## A LOOK AT 2024

- » RPOs of \$9.0 billion\* at near record levels, along with a robust pipeline, continue to provide solid line of sight for the remainder of 2024
- » Strong, focused project planning and estimating, along with investments in VDC / BIM and prefabrication, continue to create efficiencies that increase productivity and improve our execution
- » Continuing to perform well in large and growing sectors with strong demand and long-term secular trends, including **High-Tech Manufacturing** (semiconductors, EV value chain, biotech, life sciences and pharmaceutical); **Network and Communications** (including data centers); **Manufacturing and Industrial** (driven by reshoring and domestic capacity expansion and alternative energy projects); and **Healthcare**
- » Robust demand for fire life safety projects and services across most sectors
- » Solid aftermarket growth opportunities driven by energy efficiency / IAQ, HVAC retrofit, and building controls installations and upgrades
- » Oil and gas sectors continue steady pace of improvement
- » Remain diligent in serving private equity and commercial real estate customers with potential balance sheet issues
- » Continued uncertainties include elevated interest rates, the impact of global conflicts, and energy sector and supply chain disruption

\* As of 6/30/24

## KEY FINANCIAL DATA – INCOME STATEMENT

(\$ Thousands, except per share information) (Unaudited)

	For the Quarter Ended June 30,		Variance	
	2024	2023	\$	%
Revenues	\$ 3,666,897	\$ 3,045,622	\$ 621,275	20.4%
Gross Profit	684,001 18.7%	490,060 16.1%	193,941	39.6%
Selling, General and Administrative Expenses	351,193 9.6%	293,393 9.6%	57,800	19.7%
Operating Income	\$ 332,808 9.1%	\$ 196,667 6.5%	\$ 136,141	69.2%
Diluted Earnings per Common Share	\$ 5.25	\$ 2.95	\$ 2.30	78.0%



## KEY FINANCIAL DATA – INCOME STATEMENT

(\$ Thousands, except per share information) (Unaudited)

	For the Six Months Ended June 30,		Variance	
	2024	2023	\$	%
Revenues	\$ 7,099,173	\$ 5,936,054	\$ 1,163,119	19.6%
Gross Profit	1,273,310 17.9%	926,122 15.6%	347,188	37.5%
Selling, General and Administrative Expenses	680,549 9.6%	574,545 9.7%	106,004	18.5%
Operating Income	\$ 592,761 8.3%	\$ 351,577 5.9%	\$ 241,184	68.6%
Diluted Earnings per Common Share	\$ 9.41	\$ 5.28	\$ 4.13	78.2%

## KEY FINANCIAL DATA – BALANCE SHEET

(\$ Thousands)

	<i>(Unaudited)</i> <b>06/30/24</b>	<b>12/31/23</b>
Cash	\$ 807,318	\$ 789,750
Working Capital	\$ 1,067,557	\$ 928,616
Goodwill	\$ 998,571	\$ 956,549
Identifiable Intangible Assets, Net	\$ 661,920	\$ 586,032
Total Debt (excludes operating leases)	\$ 6,720	\$ 5,303
Stockholders' Equity	\$ 2,745,597	\$2,470,815
Total Debt / Total Capitalization	0.2%	0.2%

## KEY FINANCIAL DATA – QUARTER SEGMENT DETAIL

(\$ Thousands) (Unaudited)

	For the quarters ended June 30,			
	2024	% of Total	2023	% of Total
<b>Revenues from unrelated entities:</b>				
United States electrical construction and facilities services	\$ 799,994	22%	\$ 678,167	22%
United States mechanical construction and facilities services	1,655,181	45%	1,194,113	39%
United States building services	781,108	21%	775,012	26%
United States industrial services	324,047	9%	292,283	10%
Total United States operations	3,560,330	97%	2,939,575	97%
United Kingdom building services	106,567	3%	106,047	3%
Total operations	\$ 3,666,897	100%	\$ 3,045,622	100%

	For the quarters ended June 30,			
	2024	% of Segment Revenues	2023	% of Segment Revenues
<b>Operating income (loss):</b>				
United States electrical construction and facilities services	\$ 88,577	11.1%	\$ 50,722	7.5%
United States mechanical construction and facilities services	213,440	12.9%	119,847	10.0%
United States building services	46,839	6.0%	46,137	6.0%
United States industrial services	12,746	3.9%	7,887	2.7%
Total United States operations	361,602	10.2%	224,593	7.6%
United Kingdom building services	5,777	5.4%	5,927	5.6%
Corporate administration	(34,571)	—	(33,853)	—
Total operations	\$ 332,808	9.1%	\$ 196,667	6.5%

## KEY FINANCIAL DATA – ANNUAL SEGMENT DETAIL

(\$ Thousands)

	For the years ended December 31,			
	2023	% of Total	2022	% of Total
<b>Revenues from unrelated entities:</b>				
United States electrical construction and facilities services	\$ 2,783,723	22%	\$ 2,433,114	22%
United States mechanical construction and facilities services	5,074,803	41%	4,292,208	39%
United States building services	3,120,134	25%	2,754,953	25%
United States industrial services	1,167,790	9%	1,118,767	10%
Total United States operations	12,146,450	97%	10,599,042	96%
United Kingdom building services	436,423	3%	477,078	4%
Total operations	\$ 12,582,873	100%	\$ 11,076,120	100%

	For the years ended December 31,			
	2023	% of Segment Revenues	2022	% of Segment Revenues
<b>Operating income (loss):</b>				
United States electrical construction and facilities services	\$ 230,640	8.3%	\$ 148,728	6.1%
United States mechanical construction and facilities services	530,644	10.5%	330,325	7.7%
United States building services	182,995	5.9%	146,639	5.3%
United States industrial services	35,375	3.0%	19,787	1.8%
Total United States operations	979,654	8.1%	645,479	6.1%
United Kingdom building services	25,681	5.9%	29,838	6.3%
Corporate administration	(127,229)	—	(110,440)	—
Impairment loss on long-lived assets	(2,350)	—	—	—
Total operations	\$ 875,756	7.0%	\$ 564,877	5.1%



BUILD POWER SERVICE PROTECT

# Thank You

**Corporate Headquarters**

EMCOR Group, Inc.  
301 Merritt Seven  
Norwalk, CT 06851 USA

203.849.7938  
emcor\_info@emcor.net  
emcorgroup.com

Andrew G. Backman  
Vice President, Investor Relations  
ABackman@emcor.net