



May 2021 Investor Presentation

BRINGING THE FUTURE
FASTER

Forward-Looking Statements



BRINGING THE FUTURE
FASTER

This supplemental information contains forward-looking statements within the meaning of the Private Securities Litigation Reform Act of 1995. These forward-looking statements involve certain risks and uncertainties that could cause actual results to differ materially from those expressed or implied by these statements. These risks and uncertainties include uncertainty around the duration and effects of the COVID-19 pandemic, and include factors detailed in the reports we file with the SEC, including those described under “Risk Factors” in our most recent Annual Report on Form 10-K and our Quarterly Reports on Form 10-Q. These forward-looking statements speak only as of the date of this communication. We expressly disclaim any obligation or undertaking to disseminate any updates or revisions to any forward-looking statement contained herein to reflect any change in our expectations with regard thereto or any change in events, conditions or circumstances on which any such statement is based.

It should also be noted that this information contains certain financial measures, including Adjusted EBITDA, Adjusted Earnings per Share, Adjusted Free Cash Flow, Net Leverage Ratio and Liquidity that are not required by, or presented in accordance with, accounting principles generally accepted in the United States, or GAAP. These measures are presented here to provide additional useful measurements to review our operations, provide transparency to investors and enable period-to-period comparability of financial performance. A description of non-GAAP financial measures that we use to evaluate our operations and financial performance, and reconciliation of these non-GAAP financial measures to the most directly comparable financial measures calculated and reported in accordance with GAAP, can be found in the appendix under “Reconciliation of Non-GAAP Measures”.



- **AAM Overview**
- **ESG Update**
- **Electrification Product Technology**

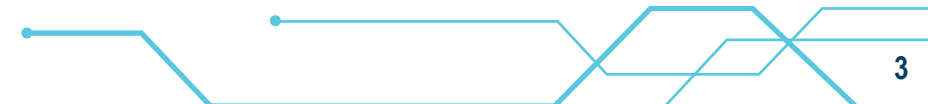

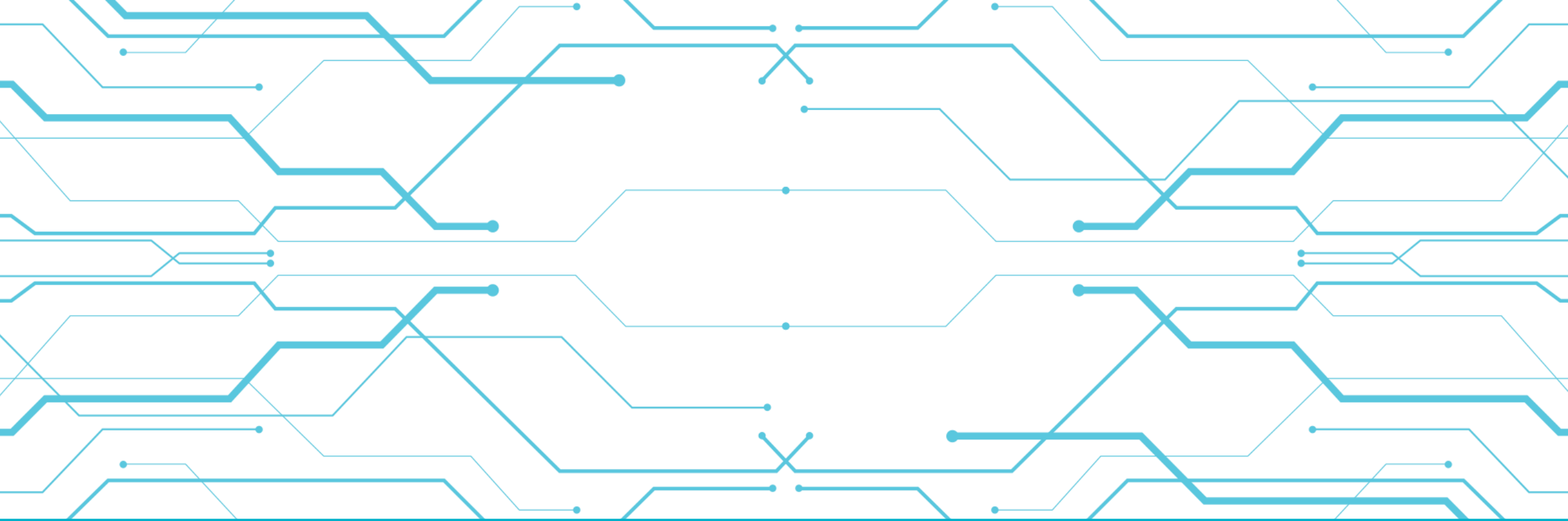

AAM Overview



BRINGING THE FUTURE
FASTER

We Are AAM



BRINGING THE FUTURE
FASTER



2020 SALES

\$4.7B

As a leading, global tier 1 automotive supplier, AAM designs, engineers and manufactures driveline and metal forming technologies that are making the next generation of vehicles smarter, lighter, safer and more efficient

AAM **delivers POWER** that moves the world through world-class quality, technology leadership and operational excellence

Fortune 500

≈20,000
ASSOCIATES



17
COUNTRIES

Nearly
80
LOCATIONS



Over
60
MANUFACTURING
FACILITIES



16
ENGINEERING CENTERS

Business Units and Market Leadership



BRINGING THE FUTURE
FASTER

DRIVELINE



- **2020 Sales: \$3.6B**
- **A Global Leader in**
 - Full-size pickup truck and SUV driveline systems
 - AWD systems for crossover vehicles
 - Damped gears, viscous dampers and rubber isolation pulleys
- **Pioneer** of disconnecting AWD Systems
- One of the **leaders** in hybrid and electric driveline solutions

METAL FORMING



- **2020 Sales: \$1.1B**
- **Largest automotive forger in the world**
- **A Global Leader in**
 - Powdered metal connecting rods
 - Differential gears
 - Axle shafts
 - Hypoid pinions
 - Ring gears
 - Transmission gears
 - CVT pulleys
 - Aluminum valve bodies

2020 AAM Highlights



BRINGING THE FUTURE
FASTER

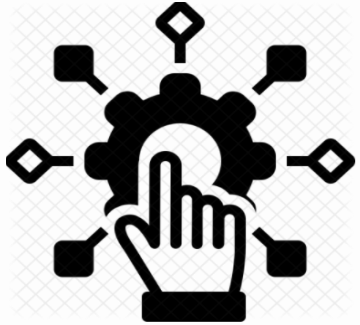

Implemented Significant Cost Savings Actions to Adjust to New Market Demand



Won Both PACE Partnership and Innovation Awards for Electric Drive Technology



Continued Strong Free Cash Flow Generation and Debt Reduction



Received Silver Quality Award at Ford's World Excellence Awards



Launched First China eDrive Program at our Liuzhou AAM JV



Formed Technical Agreement with Inovance Automotive and Awarded Multiple New Electrification Programs in China



Recognized as GM Supplier of the Year for Fourth Year in a Row



Published Comprehensive Sustainability Report



Secured Next Generation Ram Heavy Duty Axle and Driveshaft program

1Q 2021 AAM Financial Highlights



BRINGING THE FUTURE
FASTER

>\$1.4B

Quarterly
Sales

\$263M

18.4%

Record First Quarter
Adj. EBITDA Margin

\$174M

Record First Quarter
Adjusted Free Cash Flow

AAM Starts 2021 With Strong Financial Performance

Business Update



BRINGING THE FUTURE
FASTER



AAM and REE have agreed to jointly develop an exciting new electric propulsion system for e-Mobility.



AAM has been named as the sole-supplier of front and rear pickup axles for GM's Oshawa truck plant.



AAM is supplying both air-cooled and liquid-cooled **Power Transfer Units (PTU)** for the all-new Ford Bronco Sport.





2021 Financial Targets

Full Year Sales	\$5.3 - \$5.5 billion
Adjusted EBITDA	\$850 - \$925 million
Adjusted Free Cash Flow	\$300 - \$400 million

- Trending toward the high-end of ranges based on current production schedules and customers prioritizing large truck and SUV output
- These targets are based on North American light vehicle production in the range of 15.0 – 15.5 million units
- Full year targets are based on current and anticipated customer production and launch schedules
- Adjusted Free Cash Flow target assumes capital spending of approximately 4.5% of sales
- AAM expects restructuring and acquisition-related cash payments to be between \$50 and \$65 million



Environment, Social, and Governance



BRINGING THE FUTURE
FASTER

Sustainability Update



BRINGING THE FUTURE
FASTER

In 2021, AAM published a comprehensive sustainability report with the reporting framework based on SASB, GRI, and TCFD standards

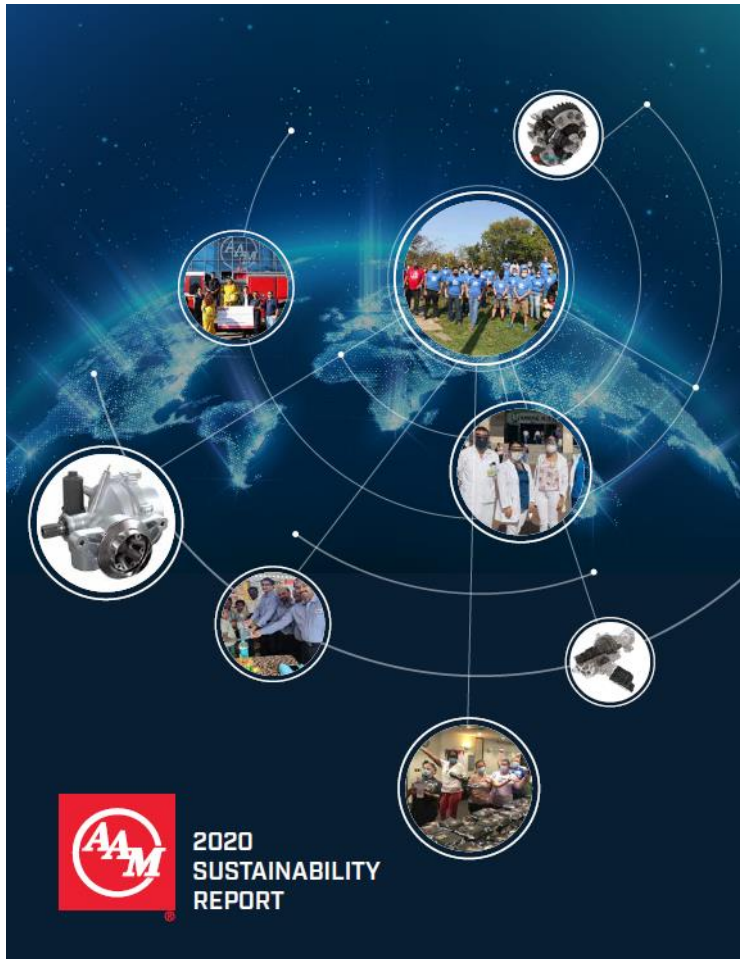

TABLE OF CONTENTS

A Message from our Chairman & CEO	1
We are AAM	2
Sustainability Priority Topics	3
Environmental	4
Our Goals	5
AAM Environmental System E ⁴	7
Environmental Initiatives	8
Carbon Disclosure Project Reporting	13
Social	14
Safety Management System S ⁴	15
Diversity, Equity and Inclusion	17
AAM360	20
#TeamAAM in the Community	26
Governance	28
Sustainability Leadership	29
Ethics and Compliance	30
Supply Chain Compliance	31
Human Rights	33
Industry Associations	33
Product	34
Research and Development	35
Electric Drive Technology	35
AAM Quality System Q ⁴	39
Appendix	
About this Report	A-1
GRI Index	A-3
SASB Index	A-11
TCFD Index	A-12

In a survey conducted by *Institutional Investor*, our Financially Material ESG Disclosures were ranked 1st out of 80+ nominated Small-cap Consumer companies*

*For our 2019 sustainability report

Sustainability Leadership and Oversight



BRINGING THE FUTURE
FASTER



Environmental
Michael K. Simonte
President

Responsible for the development of strategies, action plans, goals and performance, as well as external reporting of environmental, energy and safety goals



Social
Terri M. Kemp
Vice President – Human Resources

Responsible for social responsibility, such as promoting our people-first culture with diversity and inclusion initiatives, associate training, education and wellness programs, and support of universal human rights



Governance
David E. Barnes
Vice President & General Counsel

Serves as Chief Compliance Officer and is responsible for ESG compliance and corporate governance, including reporting to our Board of Directors and relevant committees on sustainability matters

AAM's sustainability program is managed within a well-defined governance structure, through clearly-established ownership and responsibilities at multiple levels in the organization.

Sustainability: Key Areas of Focus



BRINGING THE FUTURE
FASTER

ENVIRONMENTAL

Energy and Emissions
Reduction

Reduce Water Use
at Every Location

Reduce, Reuse, Recycle
Industrial Materials

SOCIAL

Associate Health, Safety
and Wellness

Attract, Develop, Engage
and Retain Diverse Talent

Partner with
Global Communities

GOVERNANCE

Ethical Business Practices
and Training

Cascade and Verify
Supplier Compliance

PRODUCT

Investment
in Technology

Product Quality
and Safety

Our cross-functional team of subject matter experts considered Global Reporting Initiative (GRI) standards, industry-specific standards of the Sustainability Accounting Standards Board (SASB) and the United Nations Sustainable Development Goals to prioritize sustainability topics and develop performance indicators

Key Environmental Goals



BRINGING THE FUTURE
FASTER

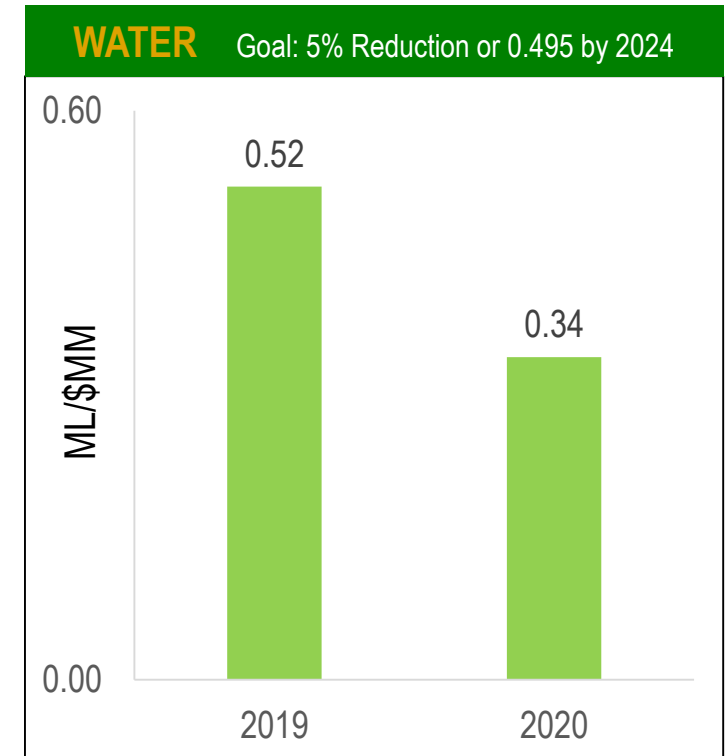
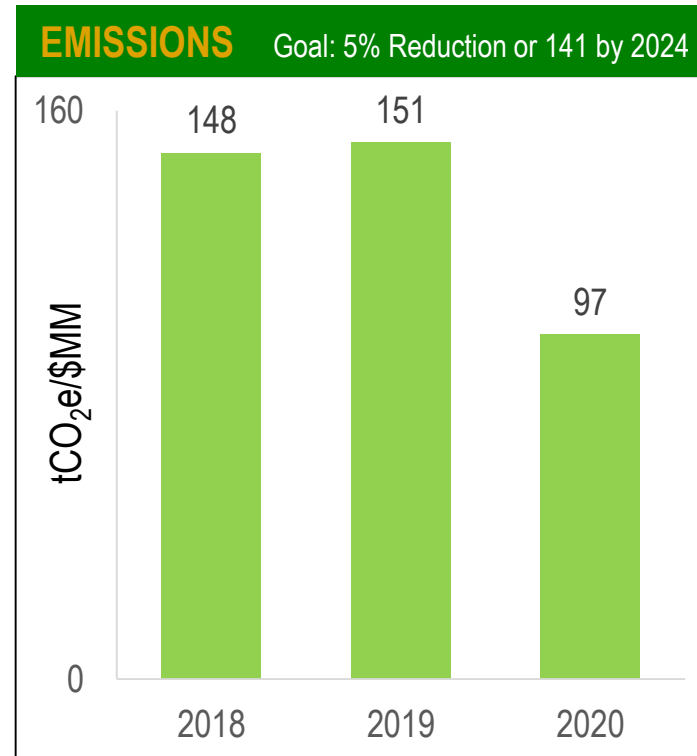
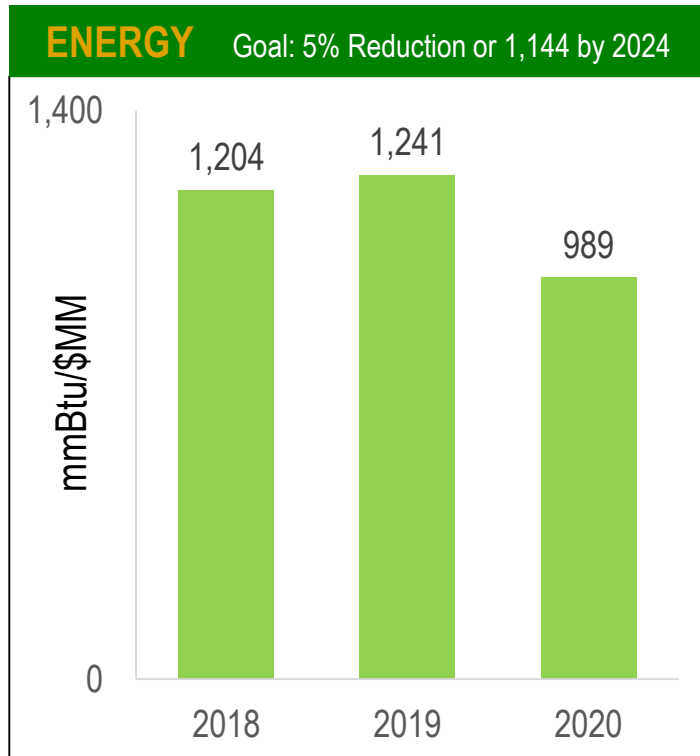

AAM has achieved initial goals
In 2021 AAM will reset goals to drive future beneficial impacts of our initiatives

Note: Refer to AAM's 2020 Sustainability Report for further detail and supporting calculations.

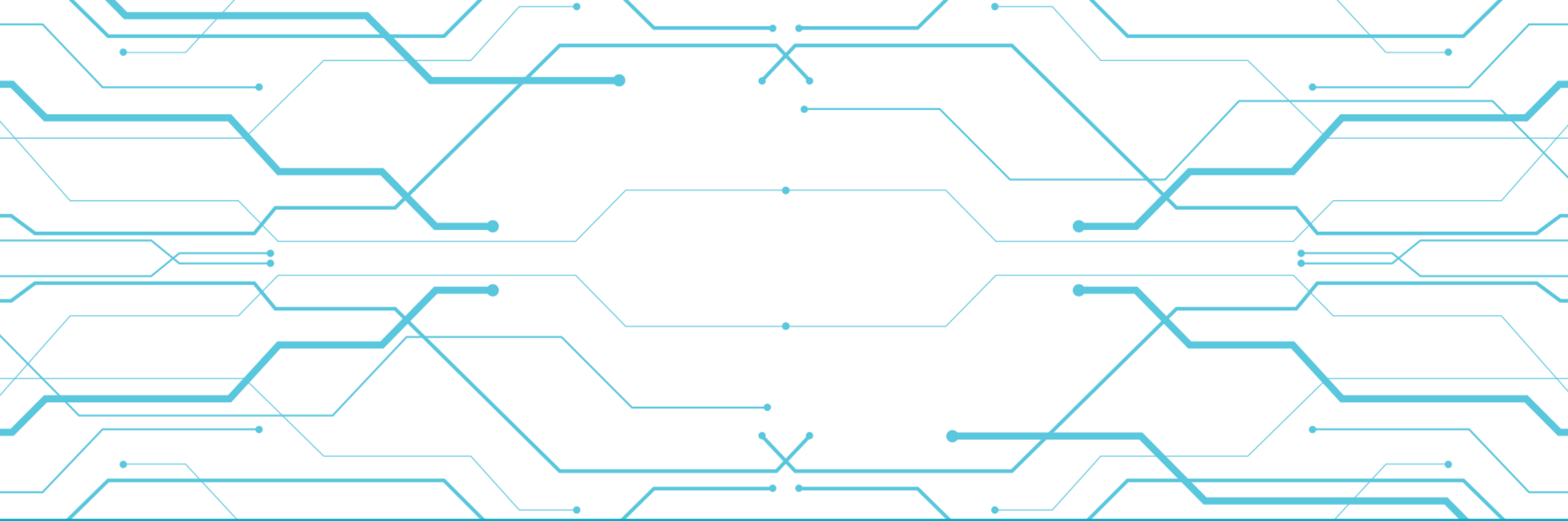

Electrification Product Technology



BRINGING THE FUTURE
FASTER



AAM anticipates the addressable sourcing market at ~\$18-20 billion by 2030

- This includes electric drive units, subsystems and components
- We offer solutions for various OEM go-to-market strategies for electric vehicles
- Our technology is a key differentiator
- We expect the market to grow past 2030

AAM's Competitive Advantage

Global Size
& Scale

Operational
Excellence

Technology
Leadership

Broad Product
Portfolio

Integration
Experience

Technical
Partnerships

**Note: Total global addressable markets is based on electric drive unit install rates across various propulsion types*

Source: IHS estimates and internal calculations

Significant Content Opportunity



BRINGING THE FUTURE
FASTER

Customer **In-House** Support

Components



Subsystems



Gearboxes

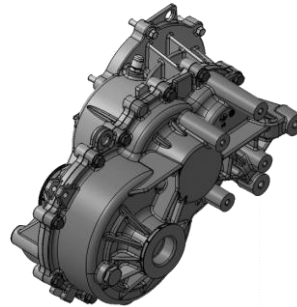

AAM CPV: Up to \$500

Customer **Outsourced** Support

Electric Drive Units

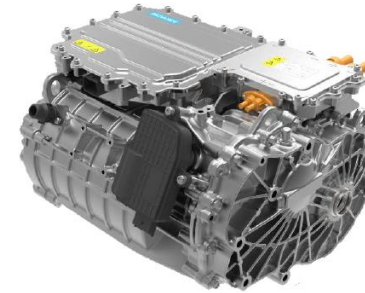

Vehicle Integration & Controls

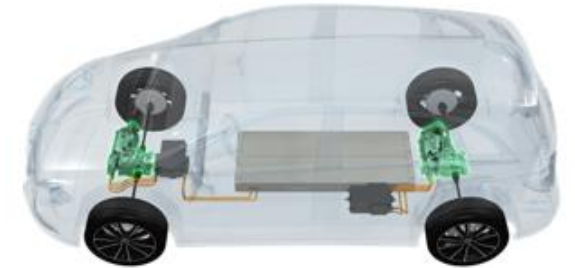

AAM CPV: Up to \$2,500+

AAM is Positioned to Support All OEM Sourcing Strategies

AAM Electrification History

Key Business Awards in Electrification To Date



BRINGING THE FUTURE
FASTER

2-in-1 Electric Drive Units

Jaguar I-PACE (Europe)

- Two P4 Electric Drive Units
- 150 kW Power Level
- Power Dense Concentric Design
- Integrated Park Lock (Front EDU only)



Launched

Baojun E300 City Car (China)

- P4 Gearbox
- 40 kW Peak Power
- Offset Gearbox Design
- Integrated Park Lock

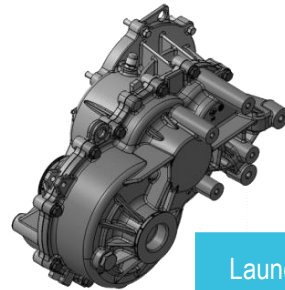

Launched

High Performance Luxury OEM (Europe)

- P3 Hybrid Electric Drive Unit
- 160kW Peak Power
- 2-speed Concentric Gearbox Design
- Integrated TracRite® eLSD

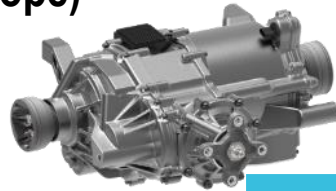

2021 Launch

3-in-1 Electric Drive Units (Platform)

AAM / Inovance 3-in-1 eDrive (China)

- P4 Platform Electric Drive Units
- Scalable Power Level based on Application
- Offset Gearbox Design
- Optional Park Lock

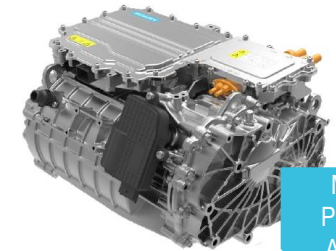

Multiple Programs Awarded

Electric Drive Components

Electronic Limited Slip Differential

- North American BEV Pick-up Truck Application

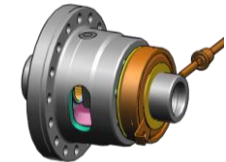

Awarded

Commercial Vehicle Differential

- North American BEV Semi-Truck Application

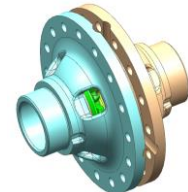

Awarded

Planetary Geartrain

- European BEV Passenger Car Application



Awarded



INOVANCE Automotive

- Technical advancement of fully integrated 3-in-1 EDUs
- Access to the largest BEV Market (China)
- High value power electronics
- Multiple programs awarded via partnership



- Invested In REE Automotive
- Electric platform leader reinventing e-mobility
- Integrates traditional vehicle components in the arch of the wheel
- Allowing for flat and modular electric platforms

Next Generation Drive Units

- Highly integrated advanced 3-in-1 technology
- Substantial improvement over currently available units
- World class efficiency and NVH
- AAM proprietary motor, inverter, and gear technology

Key Launches

- Rear e-Drive units for European high performance hybrid passenger car (multiple variants)
- Multiple program launches in China
- Multiple electric powertrain component launches on multiple vehicle segments including electric pick-up truck and commercial vehicle

AAM – REE Joint Development Agreement



BRINGING THE FUTURE
FASTER

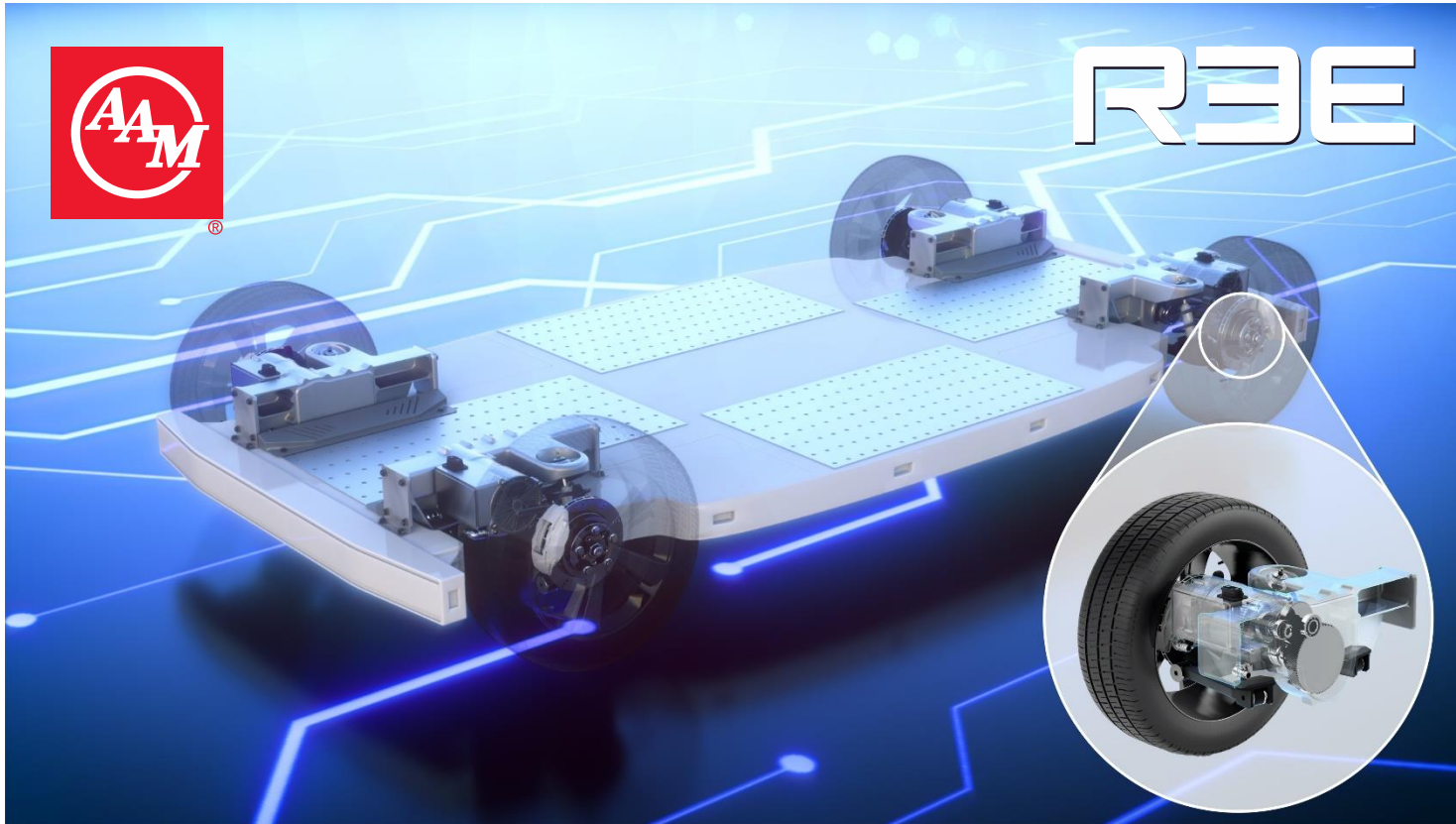

Development is expected to occur at AAM's Advanced Technology and Development Center in Detroit with delivery of prototypes planned by the end of 2021

- AAM and REE intend to incorporate AAM's next generation of **high-speed electric drive units**, which feature a **fully integrated high-speed motor and inverter**, into REE's highly modular and disruptive REEcorner™ technology.
- The REEcorner integrates critical vehicle chassis systems (propulsion, steering, braking, suspension, and controls) into a module that sits in-between the vehicle sub-frame and wheel to provide **additional space for battery storage, enabling greater vehicle range**.
- AAM's **electric drive technology** enables REE's integration of these chassis systems into the REEcorner module based on its **industry leading power density and compact design**.

■ Inovance Overview

- Leading Independent Traction Inverter Supplier in China
- Portfolio of Electric Propulsion Products
Inverters, Motors, DC/DC Converters, On-Board Chargers, 3-in-1 Electric Drive Units
- Strong Technical Team with Full Development Capability
- Competitive and Vertically Integrated Manufacturing Footprint

■ Multiple Programs Awarded via Partnership

INOVANCE
Automotive

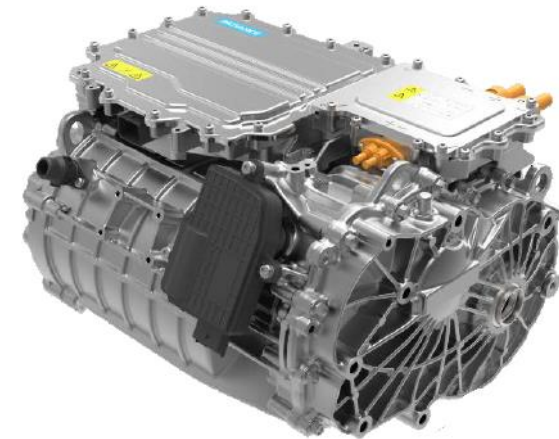

Partnership Accelerates Development of Next Generation Fully Integrated 3-in-1 EDUs and Increased Access to the largest BEV Market

AAM Next Generation Electric Drive



BRINGING THE FUTURE
FASTER

Market Critical Attributes

Outside: Best
Inside: Worst

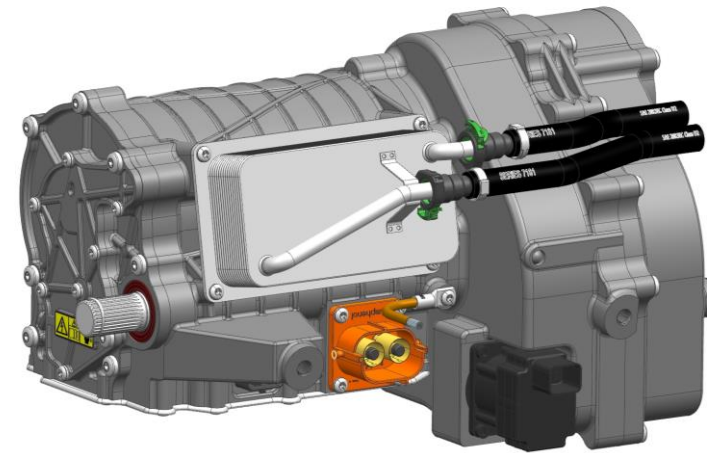
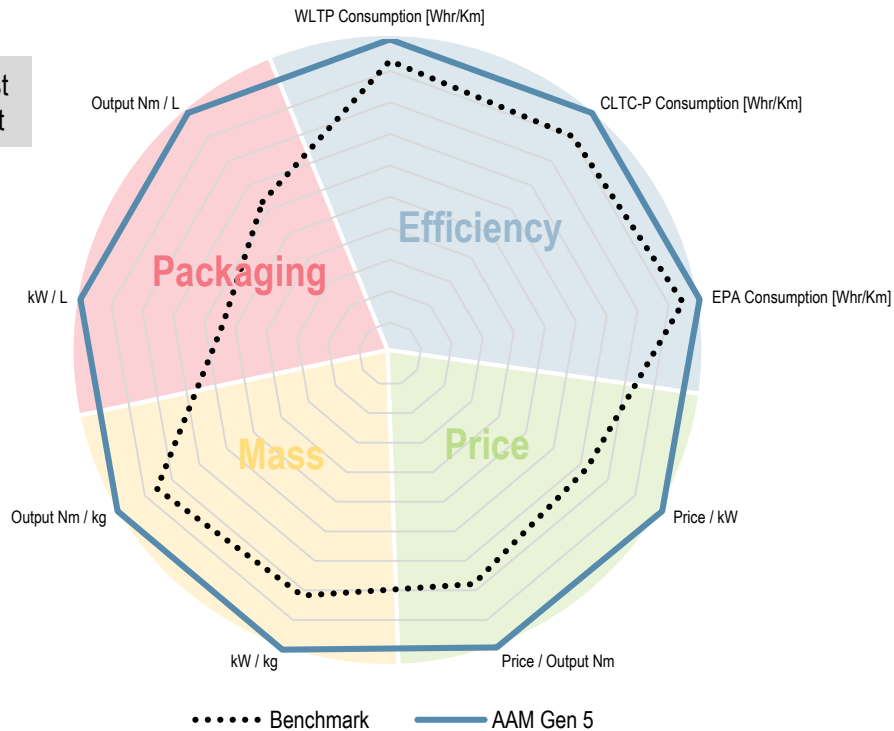

AAM Next Generation Electric Drive Units Deliver Compelling Performance

- >10%** Improvement in Mass Efficiency
- >40%** Improvement in Volumetric Efficiency
- >40%** Improvement in Power Density
- >10%** Reduced Power Loss, More Range
- Strong Value Proposition**

AAM's Next Generation Electric Drive exceeds widely recognized industry benchmark in terms of critical EDU attributes

Scalable & Modular Platform



BRINGING THE FUTURE
FASTER

AAM's Next Generation Scalable & Modular Electric Drive Units support numerous vehicle applications while optimizing capital and development costs

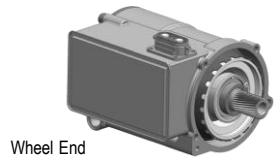

Wheel End

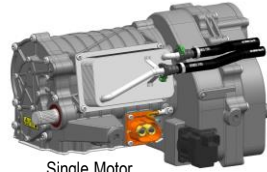

Single Motor

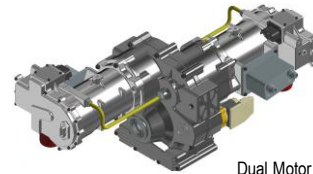

Dual Motor

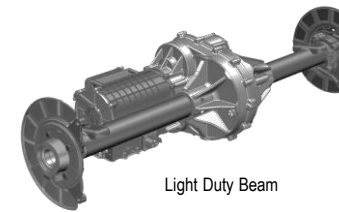

Light Duty Beam

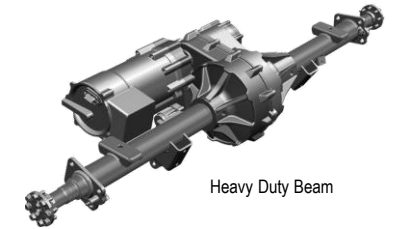

Heavy Duty Beam

Scalable Power Levels

Modular Motor Construction

Various EDU Architectures

Multiple Gear Ratios

Optional Torque
Vectoring & Disconnect



P3 HYBRID ARCHITECTURE

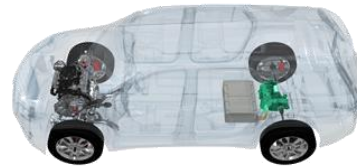

P4 SPLIT AXLE HYBRID ARCHITECTURE



P4 RWD ARCHITECTURE



P4 AWD MPV ARCHITECTURE

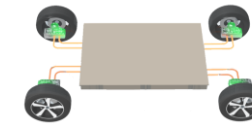

P4 AWD ARCHITECTURE



P4 FWD ARCHITECTURE

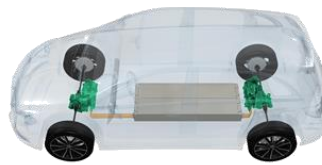

P4 AWD ARCHITECTURE



P4 4WD ARCHITECTURE

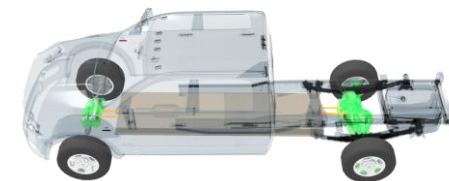

P4 4WD HD ARCHITECTURE

Denotes AAM EDU application

Electrification Summary



BRINGING THE FUTURE
FASTER

Proven electric drive systems design and integration capabilities in production

Well positioned to support all OEM sourcing strategies leveraging our strengths in software, integration, and manufacturing

Global reach and scalable product portfolio to serve all segments and major markets

Strategic partnerships to further accelerate the development and delivery of scalable, next-generation 3-in-1 electric drive systems

Highly integrated product technology resulting in improved power density, value, and efficiency

Next generation electric drive system is positioning us for continued profitable growth

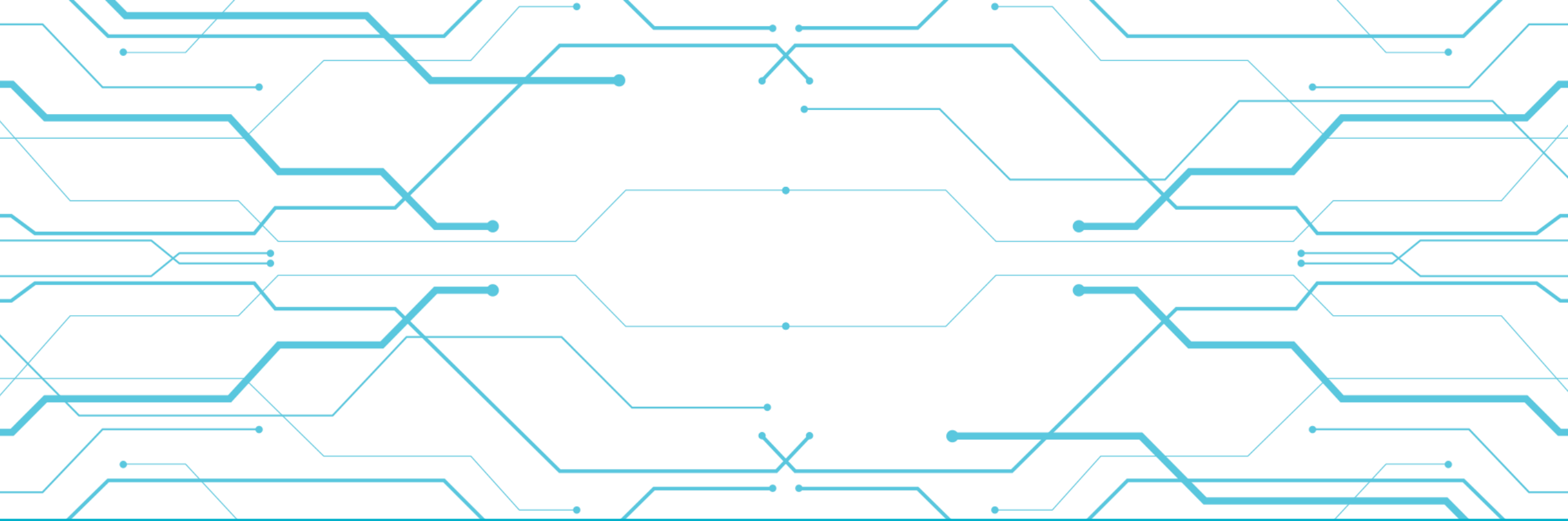

Supplemental Data



BRINGING THE FUTURE
FASTER

Reconciliation of Non-GAAP Measures



BRINGING THE FUTURE
FASTER

In addition to the results reported in accordance with accounting principles generally accepted in the United States of America (GAAP) included within this presentation, we have provided certain information, which includes non-GAAP financial measures. Such information is reconciled to its closest GAAP measure in accordance with Securities and Exchange Commission rules and is included in the following slides.

Certain of the forward-looking financial measures included in this earnings release are provided on a non-GAAP basis. A reconciliation of non-GAAP forward-looking financial measures to the most directly comparable forward-looking financial measures calculated and presented in accordance with GAAP has been provided. The amounts in these reconciliations are based on our current estimates and actual results may differ materially from these forward-looking estimates for many reasons, including potential event driven transactional and other non-core operating items and their related effects in any future period, the magnitude of which may be significant.



EBITDA and Adjusted EBITDA Reconciliation (\$ in millions)

	Three Months Ended March 31,	
	2021	2020
Net income (loss)	\$ 38.6	\$ (501.2)
Interest expense	51.1	51.5
Income tax expense	8.8	3.3
Depreciation and amortization	142.0	129.6
EBITDA	240.5	(316.8)
Restructuring and acquisition-related costs	17.5	17.6
Debt refinancing and redemption costs	1.1	1.5
Impairment charges	-	510.0
Loss on sale of business	2.6	1.0
Non-recurring items:		
Malvern fire charges, net of recoveries	1.2	-
Adjusted EBITDA	\$ 262.9	\$ 213.3
as % of net sales	18.4%	15.9%



Adjusted Earnings Per Share Reconciliation

	Three Months Ended March 31,	
	2021	2020
Diluted earnings (loss) per share	\$ 0.33	\$ (4.45)
Restructuring and acquisition-related costs	0.15	0.16
Debt refinancing and redemption costs	0.01	0.01
Loss on sale of business	0.02	0.01
Impairment charges	-	4.53
Accelerated depreciation*	0.09	0.06
Non-recurring items:		
Malvern fire charges, net of recoveries	0.01	-
Tax adjustments related to the CARES Act	-	(0.07)
Tax effect of adjustments	(0.04)	(0.04)
Adjustment for anti-dilutive effect	-	(0.01)
Adjusted earnings per share	<u>\$ 0.57</u>	<u>\$ 0.20</u>

*Please refer to definition of Non-GAAP measures



Free Cash Flow and Adjusted Free Cash Flow Reconciliation (\$ in millions)

	Three Months Ended March 31,	
	2021	2020
Net cash provided by operating activities	\$ 179.1	\$ 139.4
Less: Capital expenditures net of proceeds from sale of property, plant and equipment	(39.6)	(69.2)
Free cash flow	139.5	70.2
Cash payments for restructuring and acquisition-related costs	23.4	13.1
Cash payments related to the Malvern fire net of recoveries	11.2	-
Adjusted free cash flow	\$ 174.1	\$ 83.3



Net Debt and Net Leverage Ratio (\$ in millions)

	March 31, 2021
Current portion of long-term debt	\$ 13.7
Long-term debt, net	3,360.9
Total debt, net	3,374.6
Less: Cash and cash equivalents	601.2
Net debt at end of period	2,773.4
Adjusted LTM EBITDA	\$ 769.4
Net Leverage Ratio	3.6x



Segment Financial Information (\$ in millions)

	Three Months Ended March 31,	
	2021	2020
Segment Sales		
Driveline	\$ 1,026.1	\$ 945.9
Metal Forming	489.3	482.1
Total Sales	1,515.4	1,428.0
Intersegment Sales	(90.3)	(84.5)
Net External Sales	<u>\$ 1,425.1</u>	<u>\$ 1,343.5</u>
Segment Adjusted EBITDA		
Driveline	\$ 170.5	\$ 134.5
Metal Forming	92.4	78.8
Total Segment Adjusted EBITDA	<u>\$ 262.9</u>	<u>\$ 213.3</u>



Full Year 2021 Outlook (\$ in millions)

	Adjusted EBITDA	
	Low End	High End
Net income	\$ 40	\$ 100
Interest expense	200	200
Income tax expense	10	25
Depreciation and amortization	530	530
Full year 2021 targeted EBITDA	780	855
Restructuring and acquisition-related costs	60	60
Other	10	10
Full year 2021 targeted Adjusted EBITDA	<u>\$ 850</u>	<u>\$ 925</u>

	Adjusted Free Cash Flow	
	Low End	High End
Net cash provided by operating activities	\$ 480	\$ 580
Capital expenditures net of proceeds from the sale of property, plant and equipment	(240)	(240)
Full year 2021 targeted Free Cash Flow	240	340
Cash payments for restructuring and acquisition-related costs	60	60
Full year 2021 targeted Adjusted Free Cash Flow	<u>\$ 300</u>	<u>\$ 400</u>

Definition of Non-GAAP Measures



BRINGING THE FUTURE
FASTER

EBITDA and Adjusted EBITDA

We define EBITDA to be earnings before interest expense, income taxes, depreciation and amortization. Adjusted EBITDA is defined as EBITDA excluding the impact of restructuring and acquisition-related costs, debt refinancing and redemption costs, loss on sale of a business, impairment charges, pension settlements and non-recurring items. We believe that EBITDA and Adjusted EBITDA are meaningful measures of performance as they are commonly utilized by management and investors to analyze operating performance and entity valuation. Our management, the investment community and the banking institutions routinely use EBITDA and Adjusted EBITDA, together with other measures, to measure our operating performance relative to other Tier 1 automotive suppliers. We also use Segment Adjusted EBITDA as the measure of earnings to assess the performance of each segment and determine the resources to be allocated to the segments. EBITDA and Adjusted EBITDA should not be construed as income from operations, net income or cash flow from operating activities as determined under GAAP. Other companies may calculate EBITDA and Adjusted EBITDA differently.

Adjusted Earnings (Loss) Per Share

We define Adjusted earnings per share to be diluted earnings per share excluding the impact of restructuring and acquisition-related costs, debt refinancing and redemption costs, loss on sale of a business, impairment charges, pension settlements, certain accelerated depreciation and non-recurring items, including the tax effect thereon. We believe Adjusted earnings per share is a meaningful measure as it is commonly utilized by management and investors in assessing ongoing financial performance that provides improved comparability between periods through the exclusion of certain items that management believes are not indicative of core operating performance and which may obscure underlying business results and trends. Other companies may calculate Adjusted earnings per share differently.

Free Cash Flow and Adjusted Free Cash Flow

We define free cash flow to be net cash provided by operating activities less capital expenditures net of proceeds from the sale of property, plant and equipment. Adjusted free cash flow is defined as free cash flow excluding the impact of cash payments for restructuring and acquisition-related costs and cash payments related to the Malvern fire net of recoveries. We believe free cash flow and Adjusted free cash flow are meaningful measures as they are commonly utilized by management and investors to assess our ability to generate cash flow from business operations to repay debt and return capital to our stockholders. Free cash flow and Adjusted free cash flow are also key metrics used in our calculation of incentive compensation. Other companies may calculate free cash flow and Adjusted free cash flow differently.

Net Debt and Net Leverage Ratio

We define net debt to be total debt, net less cash and cash equivalents. We define Net Leverage Ratio to be net debt divided by the trailing 12 months of Adjusted EBITDA. We believe that Net Leverage Ratio is a meaningful measure of financial condition as it is commonly used by management, investors and creditors to assess capital structure risk. Other companies may calculate Net Leverage Ratio differently.

Liquidity

We define Liquidity as cash on hand plus amounts available on our revolving credit facility and foreign credit facilities.

US SAAR

We define US SAAR as the seasonally adjusted annual rate of light vehicle sales in the United States.

Accelerated Depreciation

In the first quarter of 2021, one of our largest customers announced their intention to cease production operations in Brazil in 2021 as part of their restructuring actions. As such, we have accelerated depreciation on certain property, plant and equipment beginning in the first quarter of 2021. In the first quarter of 2020, we accelerated depreciation for certain assets that were idled as a result of our largest customer exiting their operations in Thailand, which they announced in the first quarter of 2020.

