



# Power Integrations, Inc.

NASDAQ: POWI

July 2022

# Forward-Looking Statements/Non-GAAP Metrics

These slides accompany an oral presentation by Power Integrations, Inc., which contains forward-looking statements. Each statement relating to events that will or may occur in the future is a forward-looking statement. The Company's actual results may differ materially from those suggested in the presentation.

Information concerning factors that could cause such a difference is contained in the Company's most recent report on Form 10-K.

This presentation may also contain certain non-GAAP financial information. Reconciliations of non-GAAP financial metrics to GAAP results are available on the investor page of the Power Integrations website, <http://investors.power.com>.



# ICs for Energy Production, Transmission & Consumption



POWER  
MANAGEMENT



Technology leader in ICs for energy-efficient AC-DC power supplies



LED  
DRIVERS



High-efficiency driver ICs energizing the LED lighting revolution



GATE  
DRIVERS



Gate drivers for renewable energy, DC transmission, electric locomotives and more



MOTOR  
DRIVERS



Highly-efficient, reliable and integrated motor drivers



AUTOMOTIVE  
SOLUTIONS



Automotive solutions for efficient, compact high-voltage power conversion and control

# Comprehensive Expertise in High Voltage

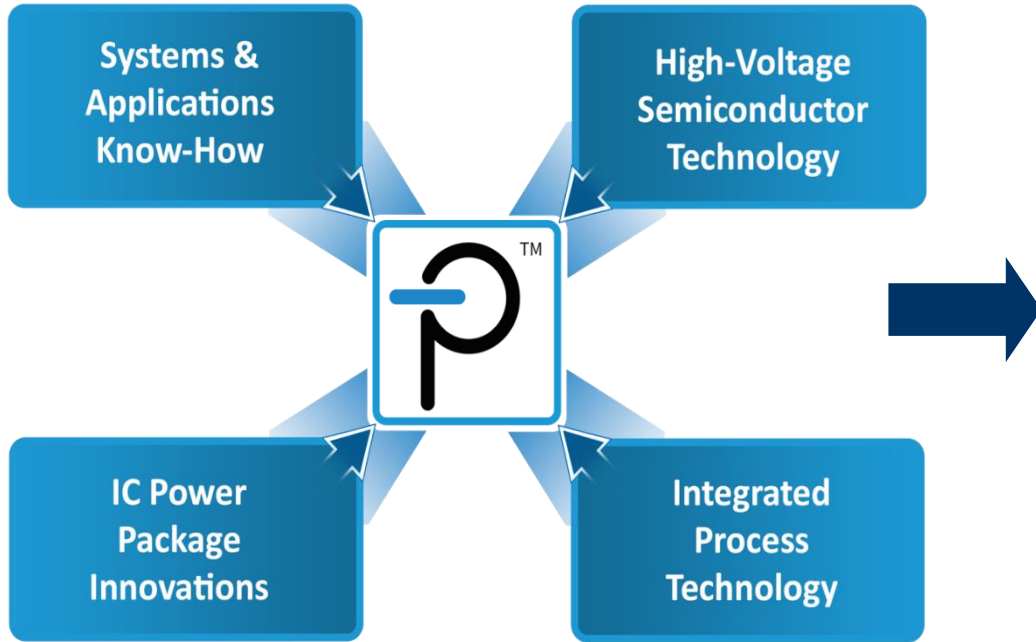

- **Ultra-simple power converters**
  - ▶ Fewer components
  - ▶ Shorter design cycles
  - ▶ Easier to manufacture
  - ▶ Higher reliability
- **BOM cost similar to discrete designs**
- **Highly energy-efficient**

# Long-Term Secular Growth Drivers

- **Ongoing transition to highly integrated power supplies**
  - ▶ Integration saves labor and materials, improves reliability
- **Enabler of reduced carbon emissions**
  - ▶ EcoSmart™ technology saves equivalent of about 1.9M homes' electricity usage each year by reducing standby consumption in electronics and appliances
  - ▶ Strong presence in renewable energy, electric transportation, efficient high-voltage DC transmission
- **Gallium-nitride (GaN) technology expands dollar content, increases efficiency**
- **Expanding high-voltage market opportunity – SAM up ~3x since 2010**
  - ▶ Advanced chargers for smartphones, tablets, notebooks
  - ▶ Home & building automation / smart lighting and appliances / IoT / smart utility meters
  - ▶ Electrification of tools and transportation
  - ▶ BridgeSwitch™ motor-drive ICs expand appliance SAM
  - ▶ LED lighting
  - ▶ Sizeable opportunity in electric vehicles

# The Power Integrations Advantage

EMI filter and bridge rectifier

Isolation transformer

Synchronous rectification

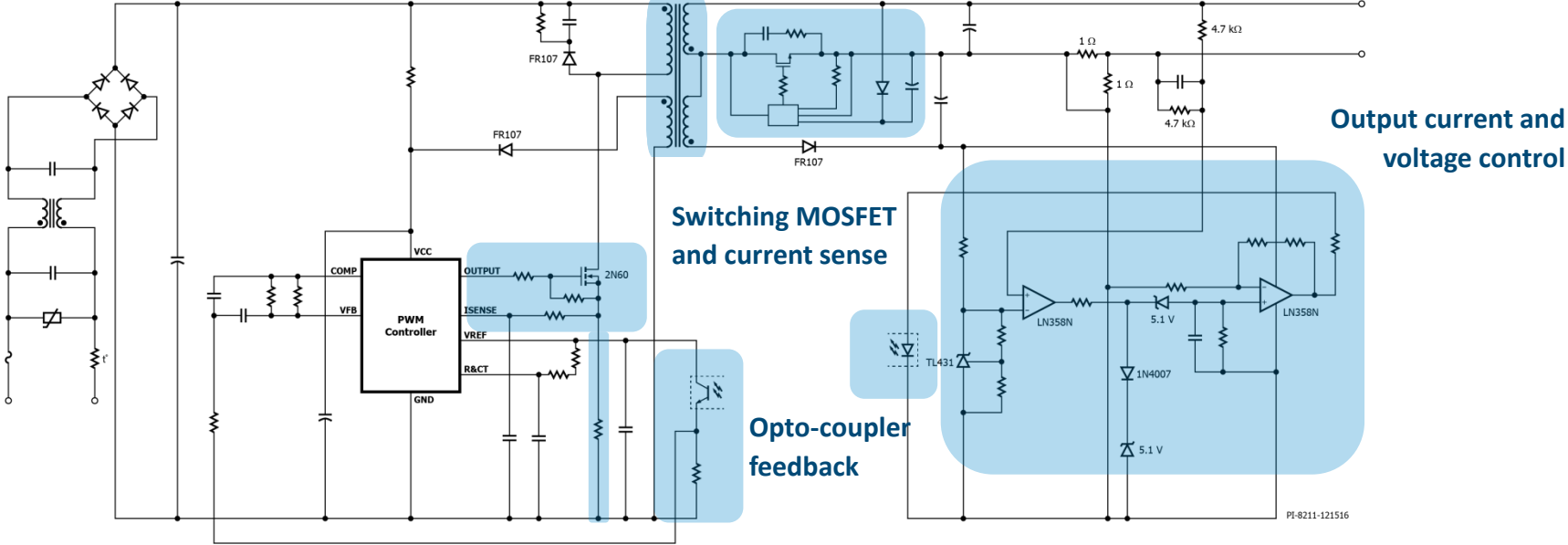

Conventional Phone Charger - More than 60 Components



# The Power Integrations Advantage

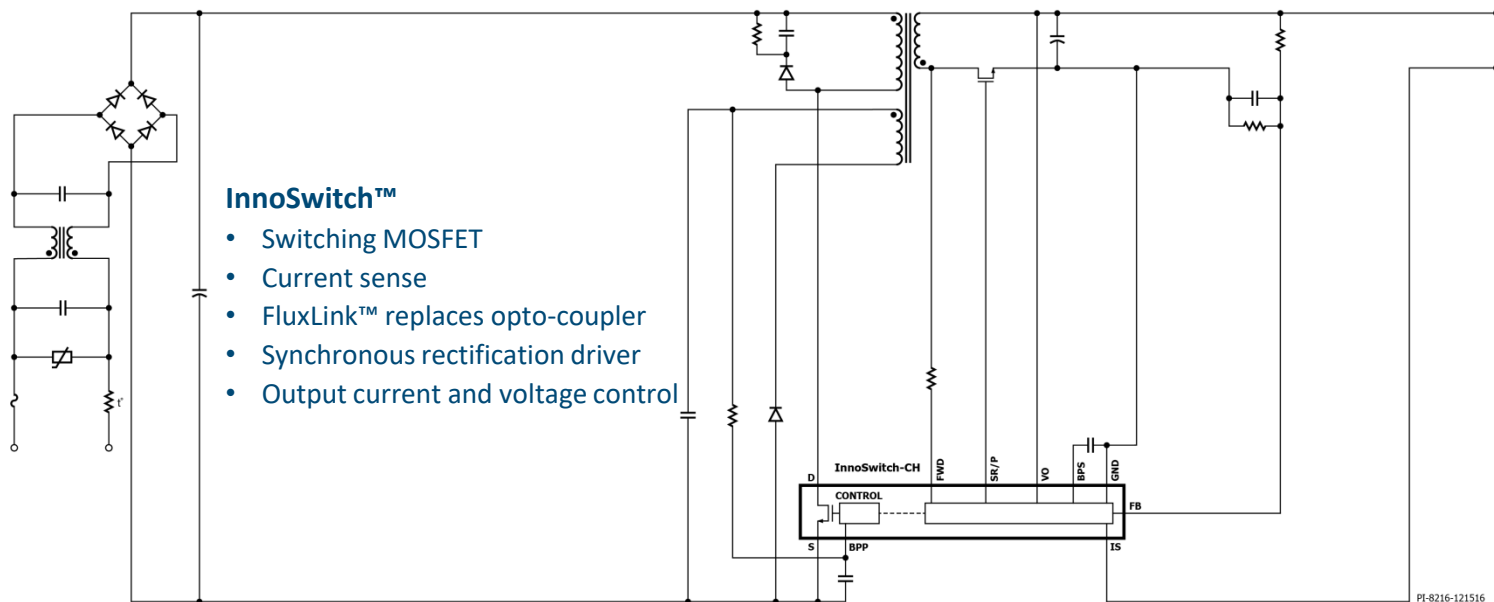

Phone-charger using InnoSwitch-CH – only 24 components

# InnoSwitch™: A Higher Level of Integration

- First IC to integrate primary and secondary sides of power supply across safety barrier
  - ▶ Enabled by FluxLink™ technology
- Drastic reduction in component count, complexity
- Highly energy-efficient
  - ▶ Very high efficiency
  - ▶ Very low standby consumption
  - ▶ Available with Si, GaN or SiC transistors

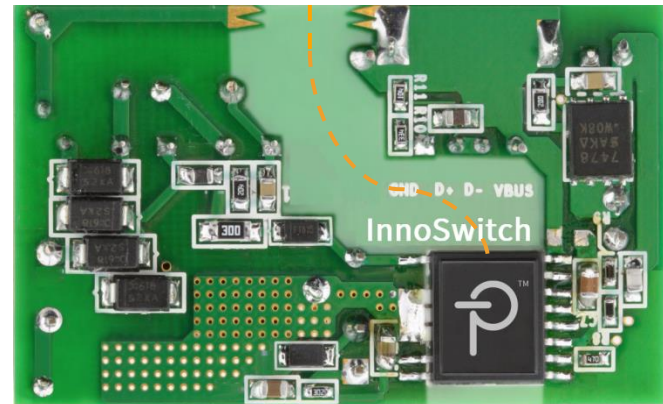
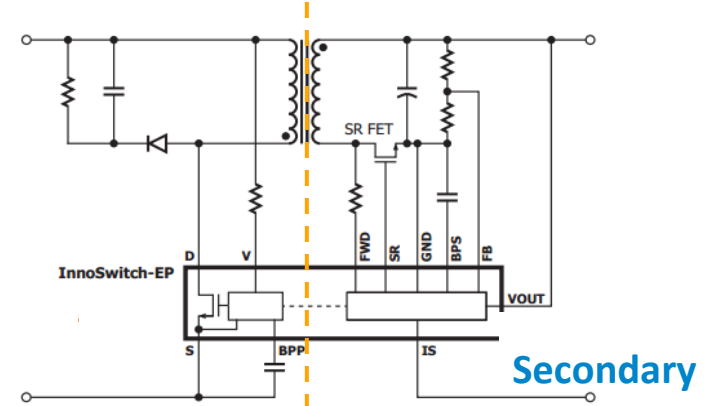



# GaN Is the Future of Power Conversion

- **GaN transistors are better than silicon**
  - ▶ More efficient, cooler, smaller power supplies
  - ▶ Eliminates heatsinks even at high power levels
- **Proprietary GaN switches integrated into our ICs**
  - ▶ Far easier to use than discrete GaN transistors
- **GaN now utilized in a broad range of POWI products and applications**
  - ▶ Advanced chargers (smartphone, tablet, notebook, multi-port)
  - ▶ TVs, appliances, USB wall outlets, more



# Spanning a Wide Power Range

- AC-DC
- LED Drivers
- Gate Drivers
- Motor Drivers

SCALE-iDriver™+ SCALE™-2

BridgeSwitch™

TOPSwitch™

TinySwitch™

Hiper Family / CAPZero™  
SENZero™ / Qspeed™

InnoSwitch™

LinkSwitch™

LED Driver Products – LYTSwitch™



# Power Everywhere



# Addressable Market of \$4B+

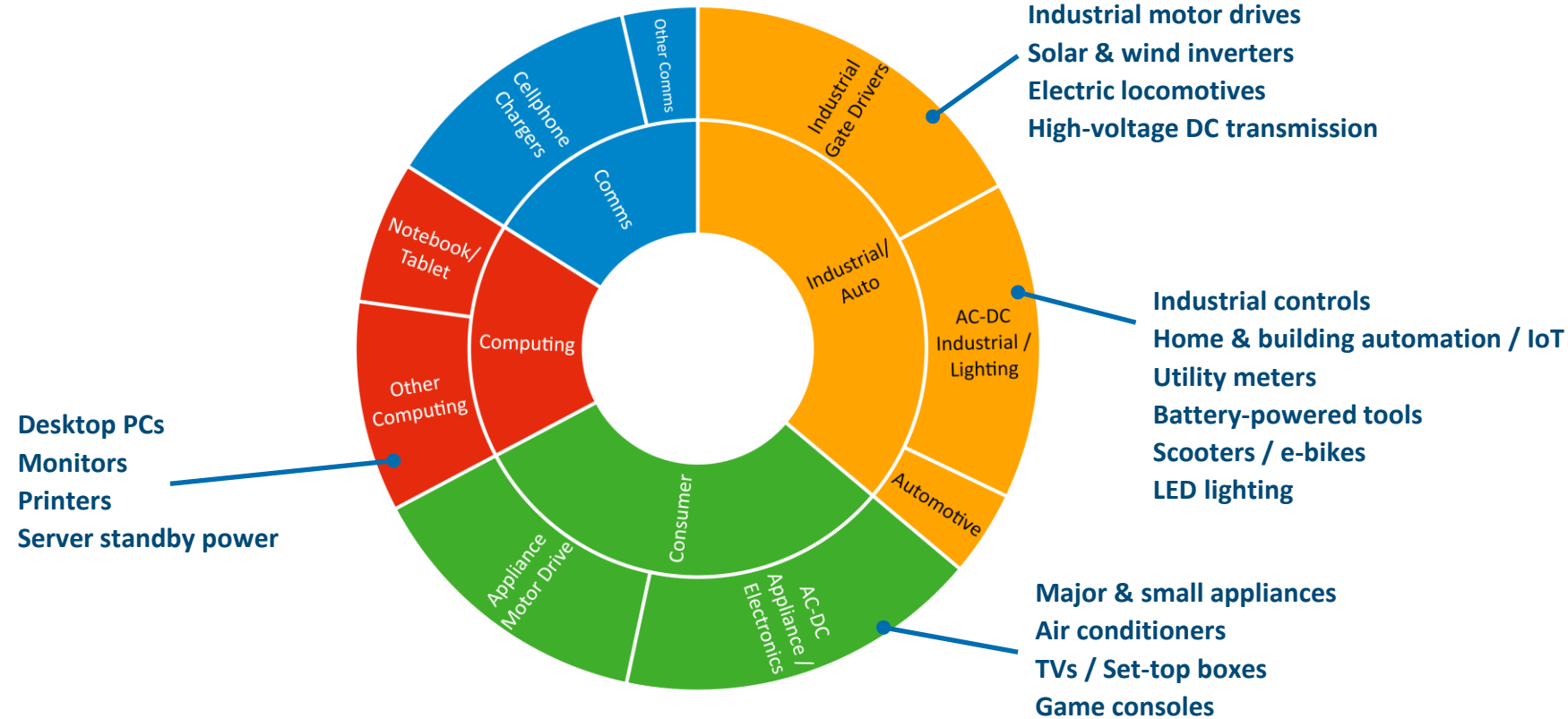

# Technology Trends Bring SAM Expansion

- **Rapid charging for mobile-device market**
  - ▶ Faster chargers = greater dollar content, higher efficiency
- **Home & building automation / smart lighting and appliances / IoT**
  - ▶ Smarter homes and appliances = more power needed = greater POWI dollar content
  - ▶ Permanently connected IoT devices need minimal standby power consumption
- **Electrification creating new opportunities in tools, transportation**
  - ▶ Lithium-ion batteries replacing gas and raw AC power for lawn equipment, vacuums
  - ▶ Electric cars, locomotives, buses, delivery vehicles, etc.
- **Conversion to brushless DC motors in appliances**
  - ▶ BridgeSwitch™ ICs target BLDC motors up to 400W
- **LED lighting – requires efficient, reliable AC-DC drivers**
- **GaN-based ICs increase dollar content and performance**



# Advanced Chargers for Mobile Devices

- **Single, high-power adapter for travel is becoming common**
  - ▶ Standardization around rapid-charge protocols and connectors
  - ▶ High power needed to charge larger batteries and multiple devices
- **Rapid growth in aftermarket brands**
  - ▶ Smaller is better
  - ▶ Notebook PC “bricks” now obsolete
- **Expanding USB charging ecosystem**
  - ▶ Wall outlets, appliances, tool chargers adding USB ports
  - ▶ Small space requires compact design, no heatsinks



# Leading USB PD Design & Innovation

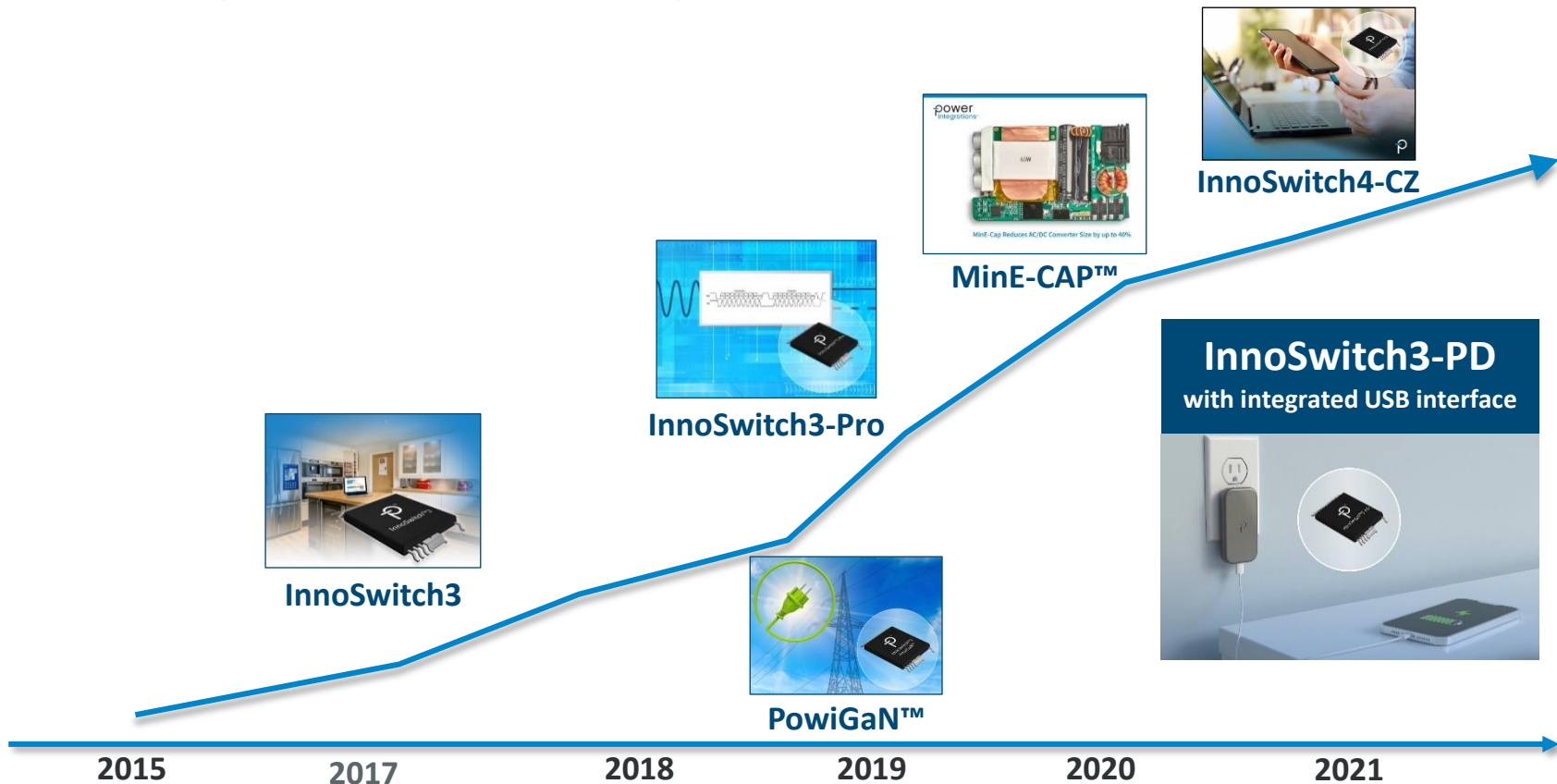

# Compact 60W Charger with InnoSwitch4-CZ & ClampZero

Uses GaN-based MinE-CAP IC to reduce size of bulk capacitors

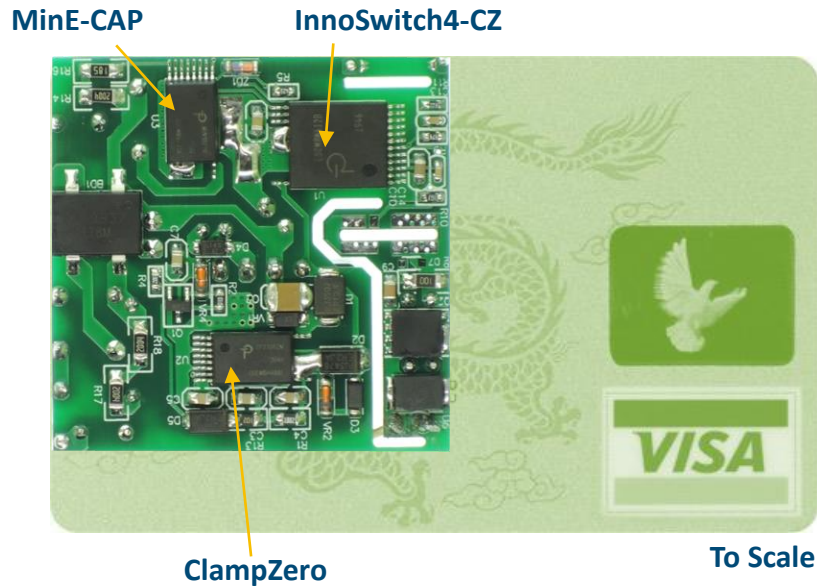
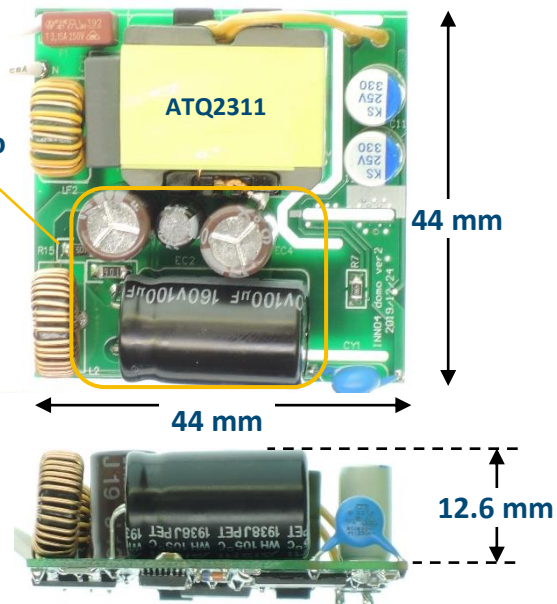

Volume = 24.4 cm<sup>3</sup>  
Power Density = 2.5 W/cm<sup>3</sup>  
No heatsinks



# PowiGaN Winning Big in Advanced Chargers

65W USB PD



100W Multi-Port



33W USB PD



33 W USB PD



47W Dual Port



45W USB PD



65 W USB PD



20W Slim Charger



# IoT / Home Automation / Fixed Charging

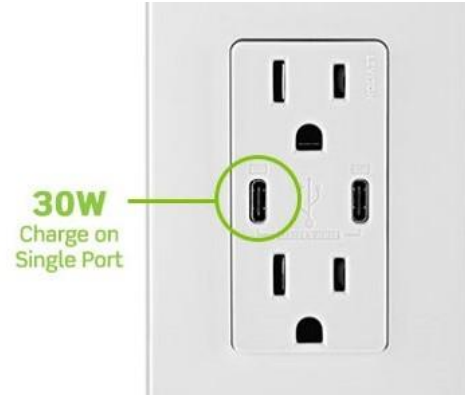
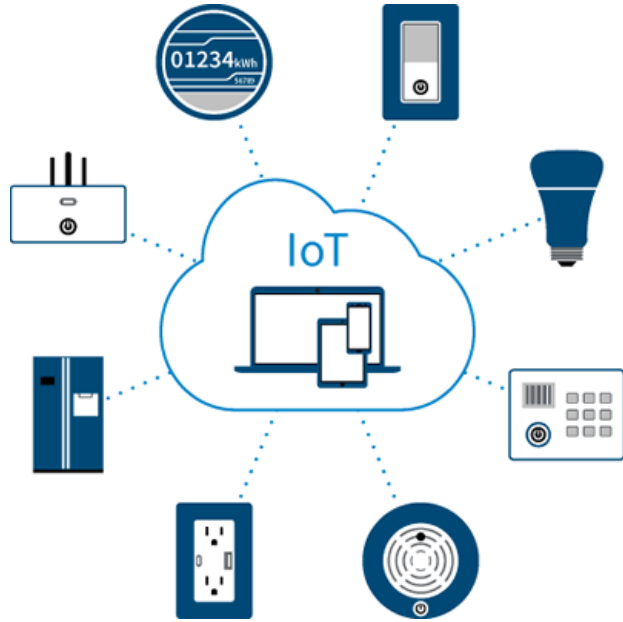

*USB-C power receptacle with InnoSwitch3*

Reliability, low standby power critical for IoT devices and USB receptacles

# BridgeSwitch™ Motor-Driver ICs for BLDC Motors

- **98.5% efficiency**
- **Integrated half-bridge architecture eliminates heatsinks**
- **Built-in protection**
  - ▶ Simplifies and shortens regulatory approval
  - ▶ Hardware fault management simplifies software
- **Ideal for appliances – white goods and industrial**
  - ▶ Ceiling fans, water pumps, air-conditioning, motors

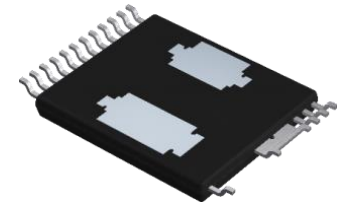
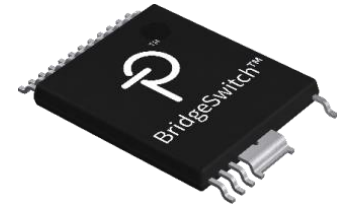

# LYTSwitch™ Drivers for LED Lighting

- Traditional light sources phasing out
- LEDs need efficient, reliable AC-DC drivers
- Integration brings reliability, efficiency, size advantage



# Gate Drivers for High-Power Market

- Acquired CT-Concept in 2012
- Addressing applications 10 kW to 1 GW
  - ▶ DC industrial motors, renewable energy, electric transportation, DC transmission
- Drivers for IGBTs and SiC switches

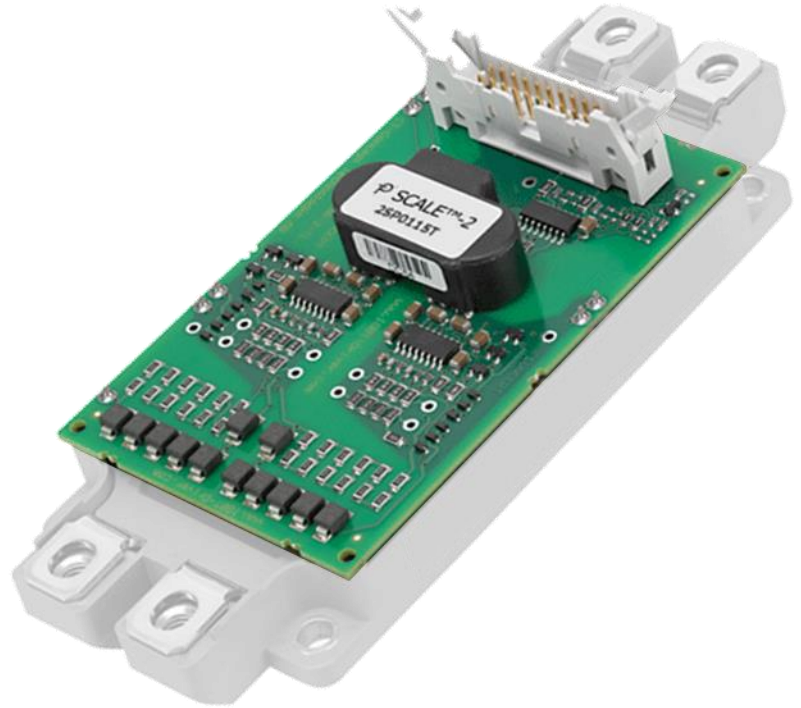

SCALE™ drivers reduce component count, enhance efficiency, reliability

# EVs Bring High Voltage to the Auto Industry

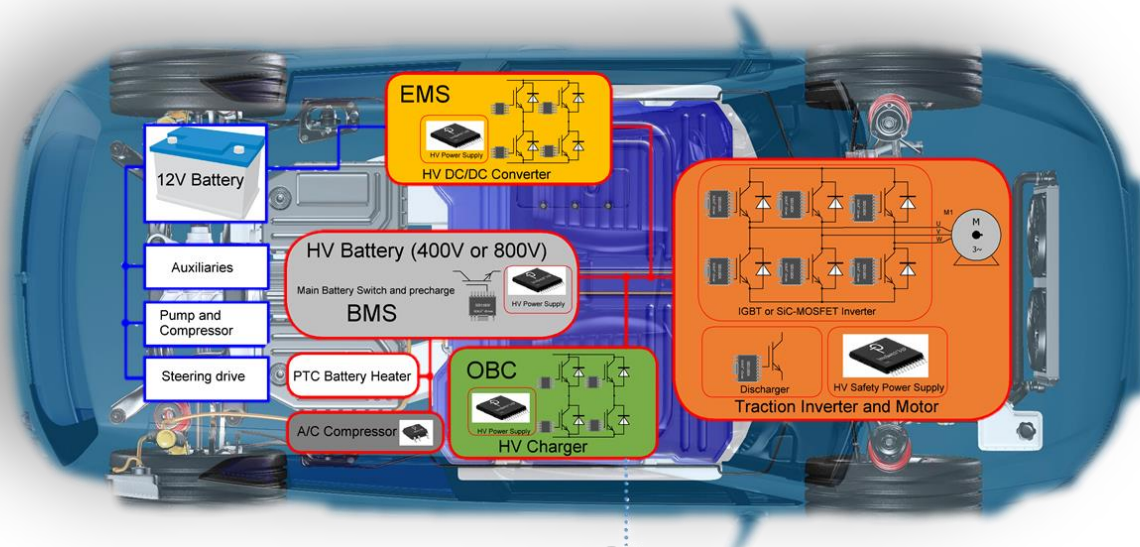

- **Tens of dollars of potential content per car**
  - ▶ Drive train, charging, DC-DC conversion
- **Several POWI products now auto-qualified**

## Traction Inverter

- ▶ SiC MOSFET or IGBT gate drivers



- ▶ Emergency power supply
  - ▶ InnoSwitch3-AQ



# Global Presence

- Headquarters in San José, California
- Design centers: U.S., Canada, Switzerland, UK, Germany, Malaysia, Philippines
- 19 field labs worldwide

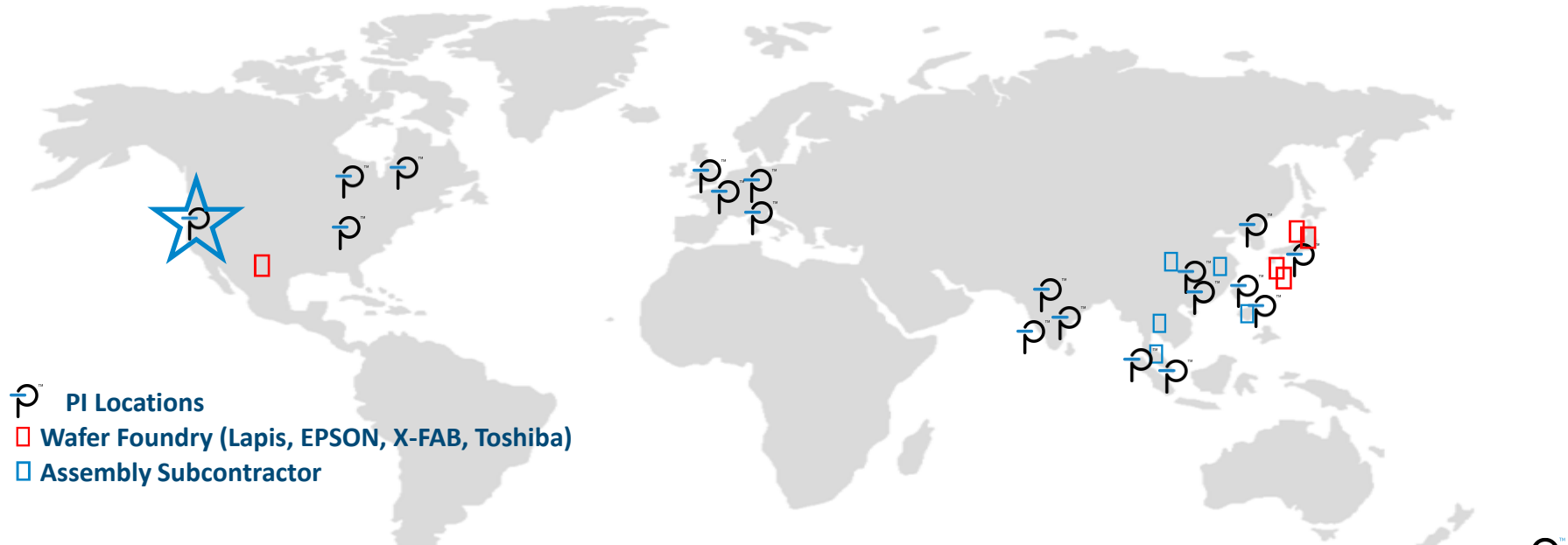

# Financials



**Best Financially Managed Semiconductor Company Achieving up  
to \$1 Billion in Annual Sales**



# Target Financial Model

- **Low-double-digit revenue growth**

- ▶ Grew 44% in 2021 vs. ~30% for analog semiconductor industry
- ▶ 10% CAGR since 2001

- **Non-GAAP gross margin 50-55%**

- ▶ 52% in 2021

- **Non-GAAP operating margin 25-30%**

- ▶ 31% in 2021

# Track Record of Growth

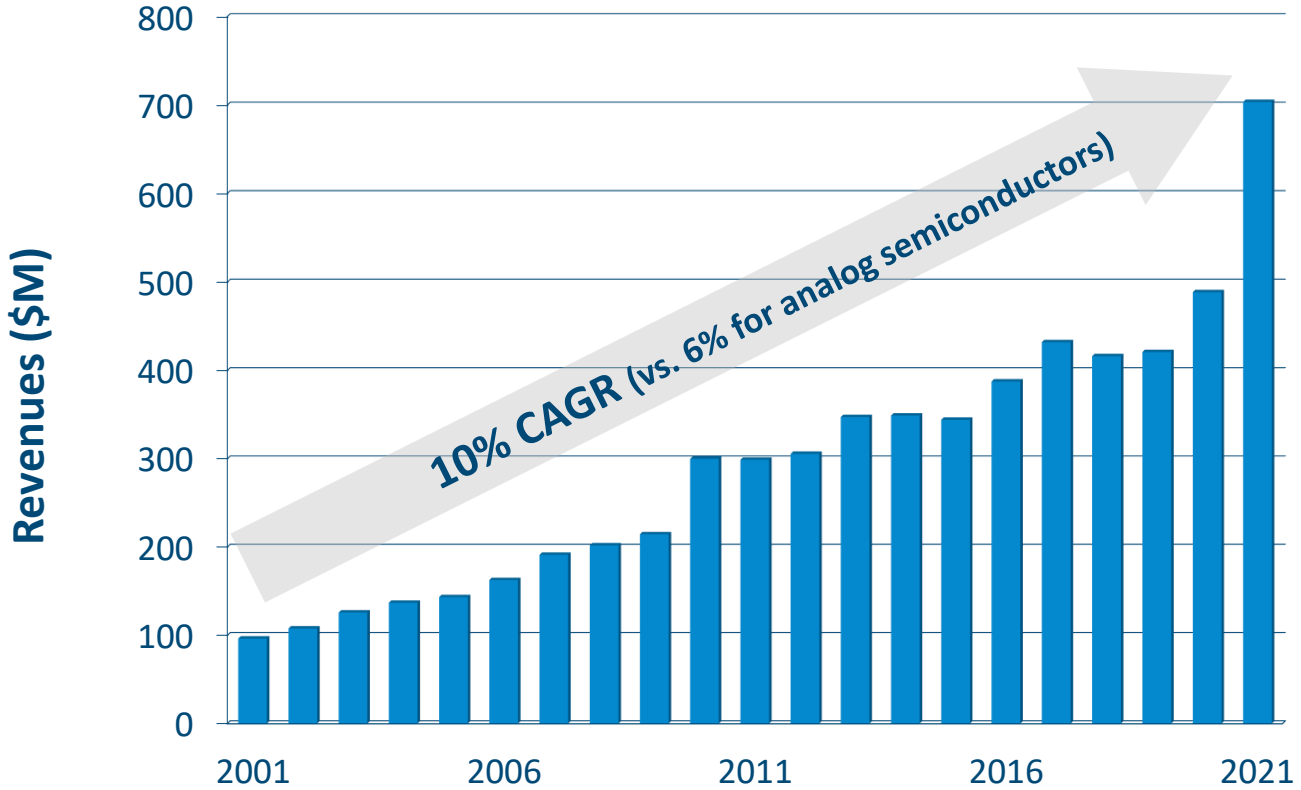

Note: Revenues prior to 2017 do not reflect ASC 606 recast; see company website for recast financial data for 2015-2016



# Three-year CAGR of 19%



Note: Revenues prior to 2017 do not reflect ASC 606 recast; see company website for recast financial data for 2015-2016

# Well-Diversified Revenue Mix

FY 2021

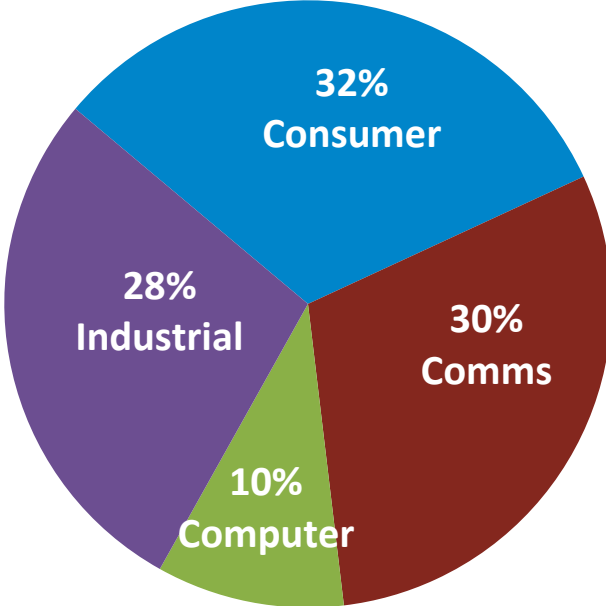

# Strong Cash Flow

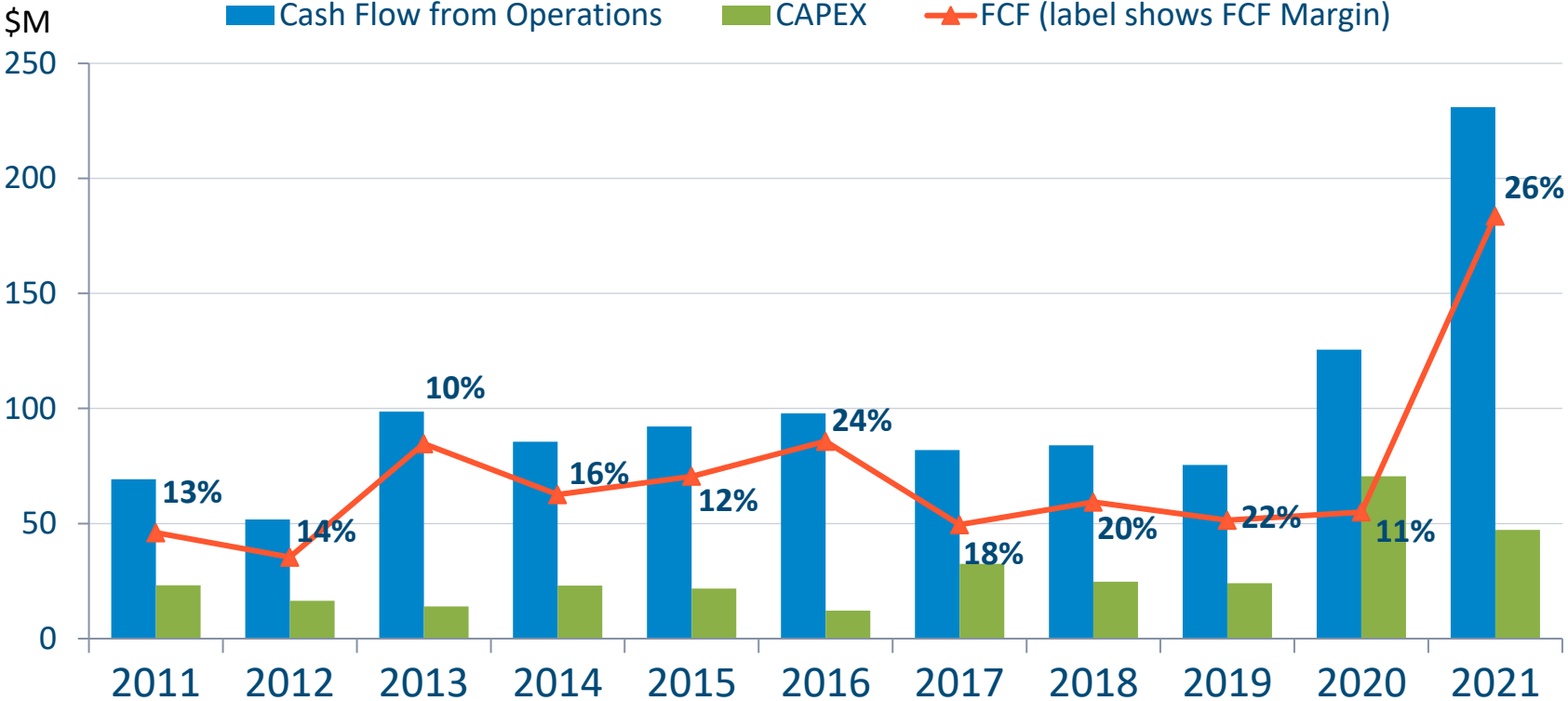

FCF = Cash flow from operations less capital expenditures

2019 GAAP Cash from Operations = \$224.5M; above excludes impact of litigation settlement



# Four-Prong Approach to Capital Management

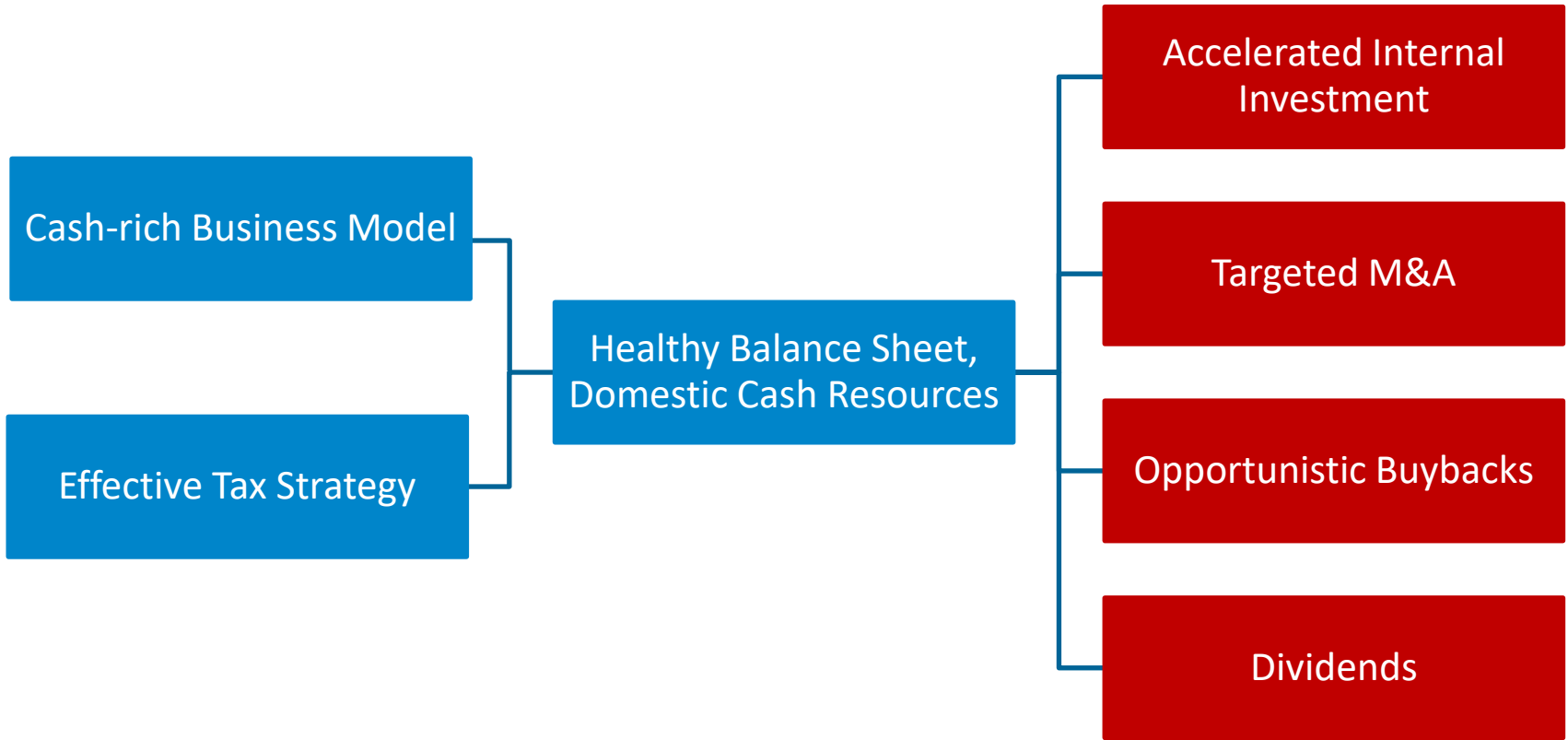

# Strong Balance Sheet

At March 31, 2022

- **\$444M cash and investments**
  - ▶ \$175M litigation settlement received in Oct. 2019
- **No debt**
- **Dividend payer since 2008**
  - ▶ Dividend increased 20% to \$0.18 in Q1 2022
- **Share count down 6% since 2008**
  - ▶ 423K shares repurchased in Q4 2021
  - ▶ 1.6M shares repurchased in Q1 2022
  - ▶ \$75M added to authorization in April

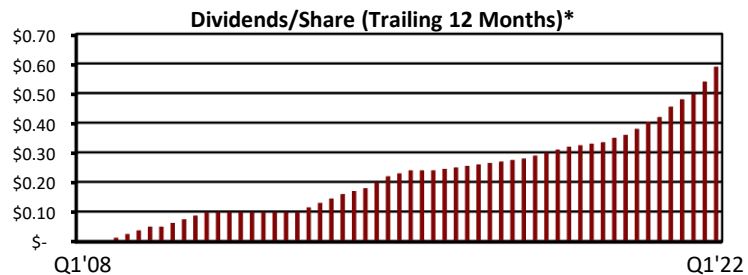
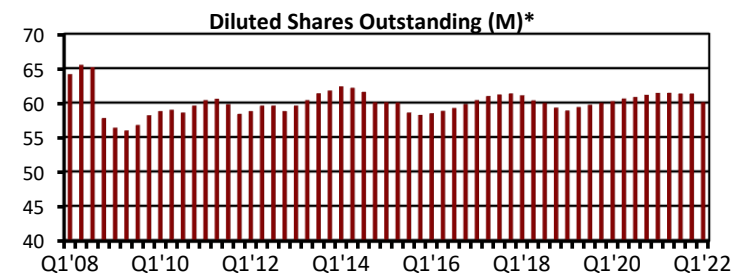
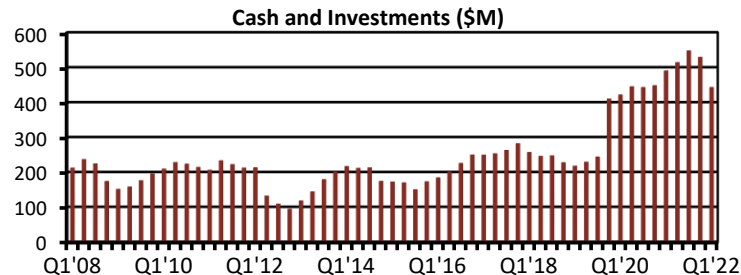

\*Adjusted for August 2020 2:1 stock split

# Sustainability: Saving energy and reducing e-waste

Visit our sustainability site for additional ESG-related information:  
<https://www.power.com/company/sustainability-and-citizenship>



# Recognized Leader in Energy Efficiency

- **Member of clean-tech stock indices**
  - ▶ The Cleantech Index (CTIUS)
  - ▶ Nasdaq Clean Edge Green Energy (CELS)
  - ▶ Ardour Global Index (AGIGL)
  - ▶ ECPI Global Clean Energy Index (GALPHCLN)
- **Twice named a top 20 sustainable stock by SustainableBusiness.com**
- **ENERGY STAR® award recipient**
- **Star of Energy Efficiency award recipient**



# EcoSmart™ Technology Slashes Carbon Emissions

- **>18 billion EcoSmart chips sold since 1998**
- **>15 TWh of standby energy saved in 2021**
  - ▶ Equivalent to entire electricity usage of 1.9M homes\*
  - ▶ Saved >6.5M tons of CO<sub>2</sub> emissions\*\*

Estimated Energy Savings from EcoSmart Devices

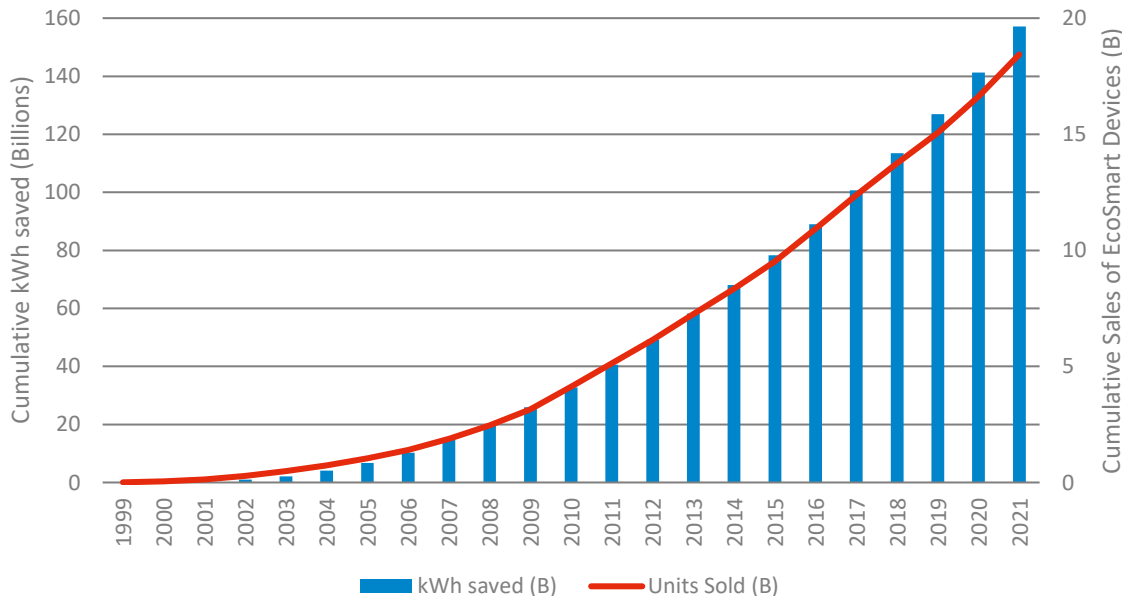

\* Source: U.S. EPA Greenhouse Gas Equivalencies Calculator

\*\*Based on 2020 U.S. average of 0.85 lbs./kWh, per U.S. Energy Information Administration



# Energy Vampire vs. LinkZero™



# Energy-Efficiency Specs Drive Innovation

- External power supply requirements in Europe tightened in 2020
- ENERGY STAR® “Most Efficient” label rewards top performers
- SEAD awards for connected efficiency
- Light bulbs in U.S. now required to be 60-70% more efficient than standard incandescent bulbs



# POWI Products Reduce E-waste

Two Hiper™ ICs replace up to 100 components

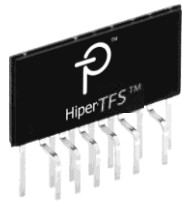

**HiperPFS, HiperLCS / HiperTFS**

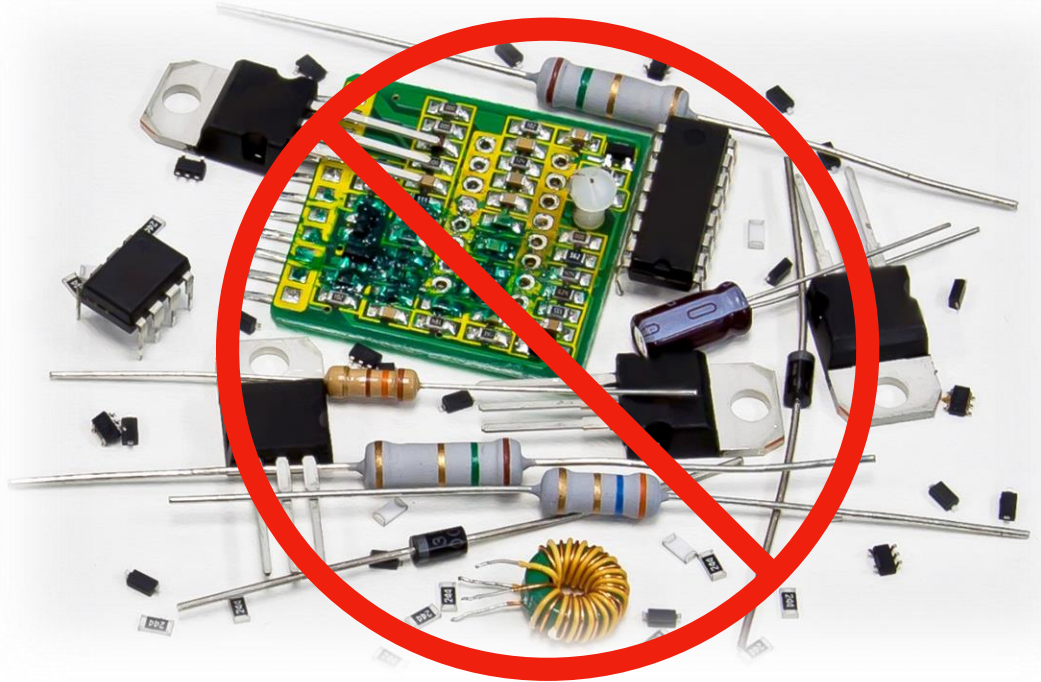

power  
integrations™