



STATE OF DELAWARE
**DEPARTMENT OF NATURAL RESOURCES AND
ENVIRONMENTAL CONTROL**

RICHARDSON & ROBBINS BUILDING
89 KINGS HIGHWAY
DOVER, DELAWARE 19901

OFFICE OF THE
SECRETARY

PHONE
(302) 739-9000

**CONCILIATION ORDER BY CONSENT
AND SECRETARY'S ORDER**

Pursuant to 7 *Del. C.* § 6005

Order No. 2024-A-0046

Issued To:

Enstructure Wilmington Holdings, LLC
Attn: Mr. Bayard Hogans, President
1 Hausel Road
Wilmington, DE 19801

Registered Agent:

Corporation Services Company
251 Little Falls Drive
Wilmington, DE 19808

Ecolab, Inc,
Attn: Mr. Jacob Kulzer, Vice President of Operations,
Pest Elimination
1 Ecolab Place
St Paul, MN 55120

Corporation Trust Company
1209 Orange Street
Wilmington, DE 19801

Enstructure Wilmington Holdings LLC ("Enstructure"), Ecolab Inc, ("Ecolab") and the State of Delaware Department of Natural Resources and Environmental Control ("DNREC" or the "Department") are endeavoring by Conciliation to ensure compliance with 7 *Del. C.* Chapter 60. The Department believes that a violation of 7 *Del. C.* Chapter 60 is continuing concerning unpermitted methyl bromide emissions from fumigation activities at the Port of Wilmington (the "Port") which is located near the confluence of the Christina and Delaware rivers. Accordingly, the Department is issuing this Conciliation Order by Consent and Secretary's Order ("Order") in an endeavor to obtain compliance with the requirements of 7 *Del. C.* Chapter 60.

WHEREAS, the Port is owned by Diamond State Port Corporation ("DSPC") and was historically operated by DSPC until October 2018;

WHEREAS, GT USA Wilmington, LLC ("GT USA") became the operator of the Port as of October 2018;

WHEREAS, on July 11, 2023, Enstructure obtained final legislative approval to replace GT USA as the operator of the Port of Wilmington;

WHEREAS, Enstructure became the operator of the Port as of July 31, 2023, taking over operations from GT USA. Enstructure facilitates cargo handling of commodities at the Port such as fruits and vegetables from other countries on which fumigation must be performed as a condition of entry into the United States;

WHEREAS, Enstructure and Ecolab contend that the import of fruits and vegetables and associated methyl bromide fumigation operations have been ongoing at the Port since approximately the mid-1980s, and are typically at their highest volume during the time period of December through April ("Fumigation Season"), though fumigation operations occur in lesser amounts year-round;

WHEREAS, fumigation operations at the Port involve the application of methyl bromide, which is a hazardous air pollutant ("HAP") and volatile organic compound ("VOC");

WHEREAS, the U. S. Department of Agriculture ("USDA") regulates the application of fumigants to commodities that are imported into the Port for the eradication of dangerous agricultural pests;

WHEREAS, Ecolab performs the required fumigation activities on the commodities received at the Port, and began such operations in December 2017 when it acquired Royal Pest Solutions, Inc. ("Royal");

WHEREAS, Ecolab follows fumigation procedures published in the USDA, Animal and Plant Health Inspection Service, Plant Protection and Quarantine ("USDA-APHIS-PPQ") Treatment Manual ("Manual") and the United States Environmental Protection Agency ("EPA") Federal Insecticide, Fungicide, and Rodenticide Act ("FIFRA") Pesticide Labeling for the use of methyl bromide;

WHEREAS, the Department issued Conciliation Order by Consent Secretary's Order No.

2012-A-0012 to DSPC on April 17, 2012 ("2012 DSPC Order");

WHEREAS, the Department issued Conciliation Order by Consent Secretary's Order No. 2012-A-0016 to Royal on May 10, 2012 ("2012 Royal Order");

WHEREAS, in an October 2, 2018, letter to the Department, GT USA affirmed it was the new operator of the Port as of October 2018, and acknowledged its responsibility to comply with the 2012 DSPC Order;

WHEREAS, in a March 18, 2019, letter to the Department, Ecolab acknowledged its responsibility to comply with the 2012 Royal Order which includes a prohibition against changes to the fumigation practices at the Port that would cause an increase in methyl bromide ambient air concentrations without prior approval of the Department, unless such changes are required by the USDA and would not create a condition of air pollution (as defined in Air Quality Management Regulations 1101 § 2.0 Definitions);

WHEREAS, the Department issued Conciliation Order by Consent and Secretary's Order No. 2021-A-0032 to GT USA and Ecolab on December 20, 2021 ("2021 GT and Ecolab Order");

WHEREAS, GT USA and Ecolab submitted a Maximum Achievable Control Technology ("MACT") Analysis to the Department on July 1, 2022, and the Department provided comments on the MACT Analysis to GT USA and Ecolab on September 9, 2022;

WHEREAS, the Department issued Conciliation Order by Consent and Secretary's Order No. 2022-A-0020 to GT USA and Ecolab on November 1, 2022 ("2022 GT and Ecolab Order") and the parties have been engaged in discussions to implement a path forward to submission and processing of a final and complete air quality permit application for methyl bromide fumigation activities at the Port;

WHEREAS, GT USA and Ecolab submitted a Revised MACT Analysis to the Department on June 2, 2023. The Department provided comments on the Revised MACT Analysis to GT USA and Ecolab on June 21, 2023, and GT USA and Ecolab provided written responses to the Department on July 24, 2023;

WHEREAS, on October 3, 2023, Enstructure accepted legal responsibility for Secretary's Orders for which GT USA had been legally responsible;

WHEREAS, the 2023 Enstructure and Ecolab Order terminated on October 31, 2024;

WHEREAS, the Department, Enstructure, and Ecolab are desirous of continuing to work toward a final and complete air quality permit application;

NOW THEREFORE, this Conciliation Order on Consent is being issued pursuant to 7 Del. C. § 6005(b)(2) for that purpose.

CONCILIATION AND ORDER

It is the desire of the Secretary that Enstructure and Ecolab take actions to ensure that its operation at the Port of Wilmington comply with Delaware law and regulations. Therefore,

IT IS HEREBY ORDERED and agreed as follows:

1. Enstructure and Ecolab will take prompt action to obtain all necessary air permits to cover methyl bromide emissions from fumigation activities at the Port and this Order will establish a framework to further define those obligations of Enstructure and Ecolab;
2. Enstructure and Ecolab reaffirm its understanding that this Order and prior Orders prohibit changes to the fumigation practices at the Port as of April 17, 2012, that would cause an increase in methyl bromide ambient air concentrations without prior approval of the Department, unless the changes are required by the USDA and would not create a condition of air pollution (as defined in Air Quality Management Regulations 1101 § 2.0 Definitions);
3. Until a final air quality permit can be issued covering the fumigation activities at the Port, or until this Order is terminated pursuant to paragraph 15, Enstructure and Ecolab commit to only fumigating products as necessary and required by USDA rule/policy.

PERMIT COMPLIANCE

4. Enstructure and Ecolab submitted an updated MACT analysis for F Shed on June 2, 2023, with information requested by the Department including specific vendor information and cost analysis. In addition to the MACT analysis, a supplemental analysis was submitted for review on September 15, 2023 to the U.S. Environmental Protection Agency (EPA). Nothing in this paragraph will prevent the Department from requesting in writing additional information regarding the MACT analysis. The Department will notify Ecolab and Enstructure in writing when its review is complete ("final written notice"). The final written notice will be sent when either the Department believes its review finds the MACT analysis and/or NSR analysis are sufficient to proceed with public notice or believes that further discussions between the parties will not result in agreement as to whether requirements are met. The Department's belief as to the sufficiency of the MACT or the NSR will not prevent Ecolab or Enstructure from submitting a permit application if Ecolab and Enstructure believe the application sufficient to meet regulatory requirements.

5. Ecolab will circulate all current submittals including but not limited to the MACT analysis dated June 2, 2023, responses to DNREC questions dated July 24, 2023, questions submitted to the EPA on September 15, 2023, and the air permit review dated March 31, 2022 to Ecolab, Enstructure and DNREC by November 30, 2024. No later than January 31, 2025, Ecolab and Enstructure will state that these documents remain final or they will request up to 90 days (no later than May 1, 2025) to revise and reevaluate the process units as defined in the MACT analysis.

6. Within 90 days of DNREC's final written notice to Enstructure and Ecolab regarding the MACT analysis, the applicants must move forward with the application process by submitting a complete application. Enstructure and Ecolab will submit a complete air quality construction permit application meeting the requirements for MACT, Delaware's air permitting regulations (*7 Del Admin. C § 1100 et seq.*), and all applicable federal requirements. For the purposes of this paragraph, a complete permit application includes (but is not limited to) all required forms (as provided by the Department on our website), zoning approval from the City of Wilmington (or proof that zoning approval has been requested), modeling for every operating

scenario (that shows downwind concentrations no greater than 1 ppm at all potential exposure locations using current topography and future permitted topography), and a plan to demonstrate continuous compliance.

7. Enstructure and Ecolab will prepare a community engagement plan with milestones and a timeline beginning at the date of application submittal regarding direct outreach from the facility regarding their operations and construction permit application. The plan will be submitted to DNREC for reference at the time of the permit application submittal but will not be part of the application. Enstructure and Ecolab must begin community engagement activities according to the plan within 30 days of the submittal. The plan is expected to include at minimum, an in-person engagement opportunity for community members and communication materials to notify nearby communities about the fumigation operations at the Port of Wilmington.

8. When the Department determines that the permit application meeting the legal requirements has been submitted, the Department will notify Enstructure and Ecolab in writing that the application is complete and will review the application and begin preparing a draft permit.

9. Prior to public notice of any draft permit, the Department may hold a public workshop on the permit application.

10. Enstructure and Ecolab may review the draft permit and submit any comments in writing to the Department within 15 calendar days from receipt of the draft permit.

11. After the draft permit is prepared and/or the Department has responded to any comments, the Department will advertise the draft permit and schedule a hearing on the matter as prescribed by law.

12. Following the public hearing, if the Secretary issues a Secretary's Order approving issuance of a permit to Enstructure and Ecolab, the Department will submit a proposed permit to EPA for a 45 calendar-day review period.

13. Upon EPA approval of a proposed permit, or upon expiration of the 45-day review

period without comment, the Department will issue the proposed construction permit to Enstructure and Ecolab.

14. When construction is complete, Enstructure and Ecolab will schedule a construction to operation inspection ("C to O inspection") and the equipment shall not be operated until completion of a successful C to O inspection and written approval by the Department.

15. Enstructure and Ecolab will develop an inspection safety plan and submit such plan to the Department for review at least 30 calendar days in advance of the scheduled C to O inspection.

16. Within 180 days of DNREC's issuance of the operating permit, Enstructure and Ecolab will submit to DNREC a Title V State Operating Permit application for methyl bromide fumigation activities, pursuant to 7 *Del. Admin. C.* § 1130, if applicable.

17. The provisions of this Order shall apply to Enstructure and Ecolab's operations at the Port until December 19, 2024, so long as Enstructure and Ecolab are in compliance with the terms of this Order. If at any time the Department determines that Enstructure and Ecolab are not in compliance with the terms of this Order, the Department shall notify Enstructure and Ecolab in writing. DNREC, Enstructure, and Ecolab shall meet and confer to determine a path forward that is compliant with this Order. If DNREC, Enstructure, and Ecolab cannot agree within 60 days of DNREC's written notice, the provisions of this Order will terminate.

INTERIM FUMIGATION MONITORING AND REQUIREMENTS

18. To the extent that Enstructure and Ecolab meet the permitting deadlines established herein and undertake all ongoing methyl bromide fumigation activities in accordance with USDA requirements and this Order, and in a safe manner that will not cause undue conditions of air pollution, the Department will not take enforcement action to shut down the fumigation activities for lack of an operating permit prior to December 19, 2024.

19. From the Effective Date of this Order and until issuance of an operating permit or

December 19, 2024, Enstructure and Ecolab will conduct methyl bromide air monitoring during all active aeration events in accordance with the Ambient Air Monitoring Plan, which is provided as Attachment A to this Order. The Ambient Air Monitoring Plan sets forth the location and frequency of monitoring, recordkeeping, and training. For purposes of this Order, "active aeration events" means the active release of methyl bromide following commodity treatment in accordance with USDA requirements.

20. If sampling pursuant to the Ambient Air Monitoring Plan indicates a detection greater than 1 ppm and less than 5 ppm, Enstructure and Ecolab will ensure that sampled concentrations do not persist beyond the below-listed time frames. If at any point one of the below-listed time frames would be exceeded on the next regularly scheduled sample, Enstructure and Ecolab will halt aeration until readings decrease to less than 1 ppm.

- A. greater than 3.0 to 5.0 ppm: no more than 90 minutes;
- B. greater than 2.0 to 3.0 ppm: no more than 160 minutes;
- C. greater than 1.0 to 2.0 ppm: no more than 240 minutes.

21. If sampling pursuant to the Ambient Air Monitoring Plan indicates a detection greater than 5 ppm, aeration will be halted for a minimum of 15 minutes or until readings decrease to less than 5 ppm, at which point aeration may resume and the monitoring requirements in the previous paragraph will be followed. In the event of a detection greater than 3 ppm, Enstructure and Ecolab will prepare a plan to reduce ground-level concentrations of fumigants. The plan will be submitted to DNREC within 48 hours following the detection.

22. Sampling and fumigation records will be compiled into monthly reports that will be submitted to the Department electronically by the 15th of each following month. Ecolab will keep records of all fumigation activities and monitoring results until issuance of an operating permit. This includes time stamped photos of all samples collected, logs of sample readings and logs of fumigation operations (date, time, quantity of methyl bromide discharged, commodity fumigated) as described in Attachment A.

23. After the effective date of this Order, methyl bromide fumigation activities shall

not violate the following operating parameters:

- A. Aeration shall not occur between the hours of 6:00 am to 10:00 pm; and
- B. Methyl bromide fumigation shall not occur in locations other than F Shed, C Shed, and G Shed as shown in Attachment B; and
- C. Fumigation operations shall not consist of more than one treatment per building during a 24-hour period.

GENERAL PROVISIONS

24. By agreeing to the terms of this Order, Enstructure and Ecolab do not admit any violation of any law, regulation, directive, instruction, Order, obligation or duty, or any liability to any person or party. Enstructure and Ecolab reserve all rights, claims, and defenses related to any of the matters described in this Order.

25. Nothing in this Order shall relieve Enstructure or Ecolab of their obligation to comply with all applicable federal, state, and local laws and regulations. Other than as expressly provided for in paragraph 16, nothing contained in this Order shall be construed to prevent, alter, or limit DNREC's ability to seek or obtain other remedies or sanctions available under federal, state, or local statutes or regulations, in response to any violation by Enstructure or Ecolab of applicable statutes and regulations, nor to limit any claims, rights or defenses otherwise available to Enstructure and Ecolab, including with respect to any such alleged violations.

26. The Department reserves the right to take additional enforcement actions regarding these and other violations by Enstructure or Ecolab, including but not limited to one or more of the following: an action under the authority vested in the Secretary by 7 *Del. C.* Chapter 60 and 7 *Del Admin. C.* § 1100 *et seq.* to revoke Enstructure or Ecolab's air quality permit(s) for the State of Delaware, an action under 7 *Del. C.* § 6005(b)(1) seeking penalties for past violations, an action under 7 *Del. C.* § 6005(b)(2) seeking penalties for continuing violations, an action in the Court of Chancery pursuant to 7 *Del. C.* § 6005(b)(2) seeking a temporary restraining order or an injunction, and the imposition of civil penalties and recovery of the Department's costs and attorney's fees pursuant to 7 *Del. C.* §§ 6005(b)(3) & (c)(1).

PUBLIC HEARING AND APPEAL RIGHTS

The Secretary is issuing this Conciliation Order on Consent anticipating that the Consent/Waiver provision herein will be signed by Enstructure and Ecolab upon receipt. Nonetheless, should Enstructure or Ecolab choose not to sign the Consent/Waiver provisions, this Order is effective and final upon receipt by Enstructure and Ecolab. Pursuant to *7 Del. C. § 6008*, any person whose interest is substantially affected by this action of the Secretary may appeal to the Environmental Appeals Board within 20 calendar days of the receipt of the Order. In the alternative, Respondent may, pursuant to *7 Del. C. § 6005(b)(3)*, request a public hearing on the Order, within 30 calendar days of receipt of the Order. A hearing would be conducted pursuant to *7 Del. C. § 6006*, and the Secretary's Order following the hearing would be subject to appeal, pursuant to *7 Del. C. § 6008*, by any person substantially affected.

To submit an appeal to the Environmental Appeals Board, there is a \$50.00 filing fee, with a check made payable to the: "Environmental Appeals Board" and sent to:

Enstructure & Ecolab
Conciliation Order on Consent and Secretary's Order
Page 11 of 13

Department of Natural Resources and Environmental Control Office
of the Secretary

Attn: Assistant to the Environmental Appeals Board

89 Kings Highway

Dover, DE 19901

Phone: (302) 739-9000

If you want a hearing and opportunity to contest this Order, you must submit your request, in writing, within 30 calendar days of receipt of this Order to:

Department of Natural Resources and Environmental Control Office
of the Secretary

89 Kings Highway

Dover, DE 19901

Phone: (302) 739-9000

Respondent may waive its right to request a hearing or to file an appeal by signing the waiver attached herein.

If you have any questions, please contact Angela Marconi at (302) 739-9402.

Nov 13, 2024

Date



Shawn M. Garvin, Secretary
Department of Natural Resources and
Environmental Control

cc: Valerie S. Edge, Deputy Attorney General
Angela Marconi, P.E., Director

Enstructure & Ecolab
Conciliation Order on Consent and Secretary's Order
Page 12 of 13

CONSENT/WAIVER OF STATUTORY RIGHT TO A HEARING

Enstructure hereby waives its right to a hearing and an opportunity to appeal or contest this Conciliation Order and agrees to the terms of this Order.

FOR ENSTRUCTURE

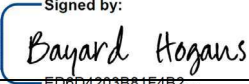
By:  _____
Signed by:
ED6D4203B81F4B2...

Date: 11/13/2024 _____

Bayard Hogans
President
Enstructure Wilmington Holdings,
LLC

CONSENT/WAIVER OF STATUTORY RIGHT TO A HEARING

Ecolab, Inc. hereby waives its right to a hearing and an opportunity to appeal or contest this Conciliation Order and agrees to the terms of this Order.

FOR ECOLAB, INC.

By:



Jacob Kulzer
Vice President of Operations,
Pest Elimination
Ecolab, Inc.

Date:

Nov 13, 2024



Ambient Air Monitoring Plan using Draeger® Tubes

**Ecolab, Inc.
Port of Wilmington, Delaware**

Project No. 124778

**Revision 1.0
12/20/2021**



Ambient Air Monitoring Plan using Draeger® Tubes

prepared for

**Ecolab, Inc.
Ecolab, Inc.
Port of Wilmington, Delaware**

Project No. 124778

**Revision 1.0
12/20/2021**

prepared by

Burns & McDonnell Engineering Company, Inc.

COPYRIGHT © 2021 BURNS & McDONNELL ENGINEERING COMPANY, INC.

TABLE OF CONTENTS

	<u>Page No.</u>
1.0 PURPOSE.....	1
2.0 SUMMARY OF METHOD.....	2
3.0 METHOD PARAMETERS.....	3
4.0 MONITORING PLAN AND PROCEDURES.....	4
4.1 Parameters.....	4
4.2 Monitoring Location.....	4
4.3 Real-Time Meteorological Monitoring.....	4
4.4 Real-Time Monitoring for Methyl Bromide.....	4
4.5 Sample Designation and Recordkeeping.....	5
4.6 Investigation-Derived Waste.....	5
5.0 EQUIPMENT AND SUPPLIES.....	6
6.0 TRAINING.....	7
APPENDIX A - DRAEGER-TUBE INFORMATION	
APPENDIX B - DRAEGER PUMP OPERATION	
APPENDIX C - FIELD FORM	

LIST OF FIGURES

Figure 1: Ambient Air Monitoring Location

LIST OF ABBREVIATIONS

<u>Abbreviation</u>	<u>Term/Phrase/Name</u>
Burns & McDonnell	Burns & McDonnell Engineering Company, Inc.
DNREC	Delaware Department of Natural Resources and Environmental Control
IDW	Investigation-derived waste
L	liter
Mg	milligrams
mL	milliliter
NOAA	National Oceanic and Atmospheric Administration
Plan	Ambient Air Monitoring Plan using Draeger® - Tubes
POW	Port of Wilmington, Delaware facility
PPE	personal protection equipment
ppm	Parts per million
Pump	Draeger Accuro® bellows pump
Tubes	Draeger® Tubes

1.0 PURPOSE

The purpose of the *Ambient Air Monitoring Plan using Draeger® - Tubes* (Plan) is to provide Ecolab, Inc. (Ecolab) with a methodology and uniform set of procedures that can be used to conduct ambient air monitoring with Draeger®-Tubes (Tubes). The data will be collected during Ecolab's operations at the Port of Wilmington, Delaware facility (POW) and used for informational purposes.

This document provides methodology and procedures for general use and operation of the Draeger Tube sampling equipment for ambient air monitoring.

2.0 SUMMARY OF METHOD

Ambient air monitoring using a Tube is performed to detect the presence of methyl bromide in the ambient air. The Tube method consists of using the Draeger Accuro[®] bellows pump (Pump) and Tubes to measure the potential presence of various chemicals in the atmosphere. Tubes are glass vials filled with a chemical reagent that reacts with a specific chemical or family of chemicals. A calibrated 100-milliliter (mL) sample of air is drawn through the Tube with the Pump. If the targeted chemical is present in the ambient air the reagent in the Tube changes color. The length of the color change in the Tube indicates the approximate concentration of the targeted chemical in the sample.

For the method associated with this Plan, Tubes are calibrated by the manufacturer (Draeger) to detect methyl bromide ranging from 0.1 to 5 parts per million (ppm). An informational sheet, published by Draeger, summarizing application range, ambient operating conditions, and reaction principles for the methyl bromide Tube is provided in Appendix A. Information, published by Draeger, summarizing the use and operation of the Pump and Tubes is provided in Appendix B.

3.0 METHOD PARAMETERS

The Tubes utilized for methyl bromide detection are considered semi-quantitative and have a standard deviation of plus or minus 15 percent (%) to 20%. Ambient operating temperatures range from approximately 35 degrees Fahrenheit (°F) to 104°F or 2 degrees Celsius (°C) to 40°C with an absolute humidity less than 40 milligrams (mg) of water per liter (L). Draeger manufactures specific equipment that can be incorporated into the sampling system to accommodate sample collection if ambient temperatures are outside of the range identified above. Based on climatological data for Wilmington, Delaware, in winter months, ambient temperatures outside of the Tubes' operating range are not typically expected.

4.0 MONITORING PLAN AND PROCEDURES

This section describes the components of the ambient air monitoring plan and procedures.

4.1 Parameters

Real-time monitoring will be conducted for methyl bromide and meteorological conditions.

4.2 Monitoring Location

Monitoring will be conducted at the Terminal Ave/I-495 South entrance ramp near the POW at the location shown on Figure 1. The exact monitoring location will be based on safe and ready access to be protective of worker safety and that of others in the vicinity of the monitoring location.

4.3 Real-Time Meteorological Monitoring

Real-time meteorological monitoring for ambient air temperature, relative wind speed, wind direction, barometric pressure and relative humidity will be measured with the applicable handheld equipment identified in Section 5.0 of this Plan. The absolute humidity is necessary to verify monitoring is within the method parameters identified in Section 3.0 of this Plan. The absolute humidity will be calculated utilizing the meteorological parameters that are monitored and a publicly available calculation method, such as (but not limited to) the Moisture Calculator from the National Oceanic and Atmospheric Administration (NOAA), available here: <https://www.ready.noaa.gov/READYmoistcal.php>.

Metrological monitoring will be performed immediately prior to, and immediately after, the real-time monitoring for methyl bromide which is explained in Section 4.4 of this Plan. The results from meteorological monitoring will be recorded on the field data form provided in Appendix C.

Supplemental meteorological monitoring data, if necessary due to unforeseen circumstances, for Wilmington, Delaware can be acquired by accessing real time data available at the NOAA website <https://www.noaa.gov/weather>.

4.4 Real-Time Monitoring for Methyl Bromide

Real-time monitoring for methyl bromide will be conducted using the Tubes based on the method described in Section 2.0 of this Plan. Monitoring will commence within the first 15 minutes of active fumigation, each night that fumigation is occurring at the POW. In accordance with Draeger's prescribed procedures, it will take approximately eight minutes to complete the 100 mL ambient air sample and the Tubes will measure methyl bromide concentrations between 0.1 and 5 ppm.

A Draeger Tube Warmer (original equipment manufactured by Draeger and also referred to as a Hot Pack in the Draeger Handbook provided in Appendix B) will be incorporated into the sampling system, according to Draeger specifications, if the ambient air temperature is observed to be below 35°F at the time of sampling.

The Tubes will be continuously observed during the measurement for changes in color of the reagent in the Tubes. A change in color to the reagent indicates the presence of methyl bromide. The Tubes will be observed immediately upon completion of the prescribed measurement period (the period in which the 100 mL sample of ambient air is drawn through the Tube) to determine the concentration of methyl bromide. The Tubes will be observed in front of a bright background, such as a blank white piece of paper, in good light, utilizing a flashlight at night if necessary, and next to an unused Tube of the same type for comparison. The Tubes will be photographed with a time-stamp to document the measurement. Measurements will be repeated approximately every 30 minutes during active fumigation.

Meteorological data will be recorded on the field data form provided in Appendix C.

4.5 Sample Designation and Recordkeeping

Each real-time measurement of meteorological parameters and methyl bromide concentrations will be identified by monitoring location, date, and time as recorded on the field data form. Electronic records specific to the ambient air monitoring activities will be maintained at POW. These records will also be compiled into monthly reports that will be submitted to the DNREC by the 15th of each following month. Records to be maintained include time stamped photos of all Tubes, logs of sample readings, and logs of fumigation operations (date, time, quantity discharged, commodity fumigated).

4.6 Investigation-Derived Waste

Investigation-derived waste (IDW) and any other expendable material used for monitoring will be properly containerized and properly disposed. Care should be given to containerization of spent Tubes as they are glass and have the potential to cause cuts or punctures.

5.0 EQUIPMENT AND SUPPLIES

Equipment and materials to be used during the collection of ambient air for methyl bromide detection will typically include the following items:

- Draeger Accuro® bellows pump,
- Tubes calibrated for detection of methyl bromide,
- Draeger Tube Warmer (when necessary),
- Handheld thermometer,
- Handheld hygrometer (relative humidity detector),
- Handheld barometer,
- Calculator, electronic tablet, etc.,
- Camera,
- Field forms,
- Disposable gloves (nitrile, etc.) and other health and safety equipment required by situation (personal protection equipment (PPE), traffic control, etc.), and
- Refuse container(s) suitable for disposal of IDW.



6.0 TRAINING

All personnel conducting ambient air monitoring for methyl bromide shall be trained on the proper use and operation of the Tubes and the methods outlined in this Plan. All personnel operating or handling the Tubes sampling system must be aware of the applicable handling procedures and safety precautions, as well as for any other materials or supplies required to complete the work.

Path: \\bmc\dfs\clients\EN\ECOL\LAB\124778_AirDispersion\Studies\Air\2020 Permit\App\PostApplication\Monitoring\Plan\GIS\Ecolab_Monitoring_TerminalAve495Ramp\Ecolab_Monitoring_TerminalAve495Ramp.aprx 12/3/2021
Service Layer Credits: Hybrid Reference Layer: Esri Community Maps Contributors, Delaware FirstMap, New Jersey Office of GIS, Esri, HERE, Garmin, SafeGraph, INCREMENT P, METANASA, USGS, EPA, NPS, US Census Bureau, USDA



Legend

-  Monitoring Location
-  Fumigation Shed
-  Port of Wilmington

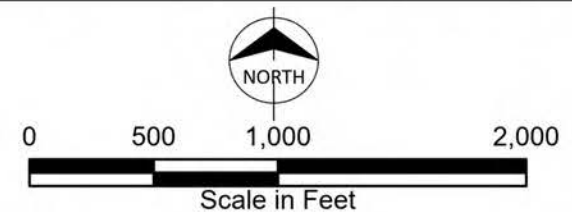

Figure 1
Methyl Bromide Monitoring Location
Ecolab, Inc.
Port of Wilmington
Wilmington, Delaware

APPENDIX A - DRAEGER TUBE INFORMATION

Methyl Bromide 0.1/a

Order No. 37 06 301

M

Application Range

Standard Measuring Range:	0.1 to 5 ppm	/ 5 to 50 ppm
Number of Strokes n:	10	/ 2
Time for Measurement:	approx. 8 min.	/ approx. 4 min.
Standard Deviation:	± 15 to 20 %	
Color Change:	bright → green	

Ambient Operating Conditions

Temperature:	2 to 40 °C
Absolute Humidity:	< 40 H ₂ O/L

Reaction Principle

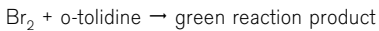
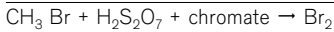

Cross Sensitivity

Carbon tetrachloride: < 2 ppm no reading. In the presence of perchloroethylene or trichloroethylene, a methyl bromide measurement is not possible! Sulfuryl fluoride, phosphine, ethylene oxide, ammonia, hydrogen cyanide, chloropicrin and formaldehyde are not indicated below their threshold values. 2 ppm ethylene dibromide is indicated with approximately the same sensitivity. 0.5 ppm vinyl chloride is indicated with a reading of less than 0.1 ppm. 2 ppm 1.1 dichloroethylene is not indicated and 20 ppm 1.2 dichloroethylene is indicated with a low reading of 3 ppm.



D-8692/2019



On more than 420 pages you can learn all about Dräger-Tubes.
[Download here the complete handbook.](#)

APPENDIX B - DRAEGER HANDBOOK

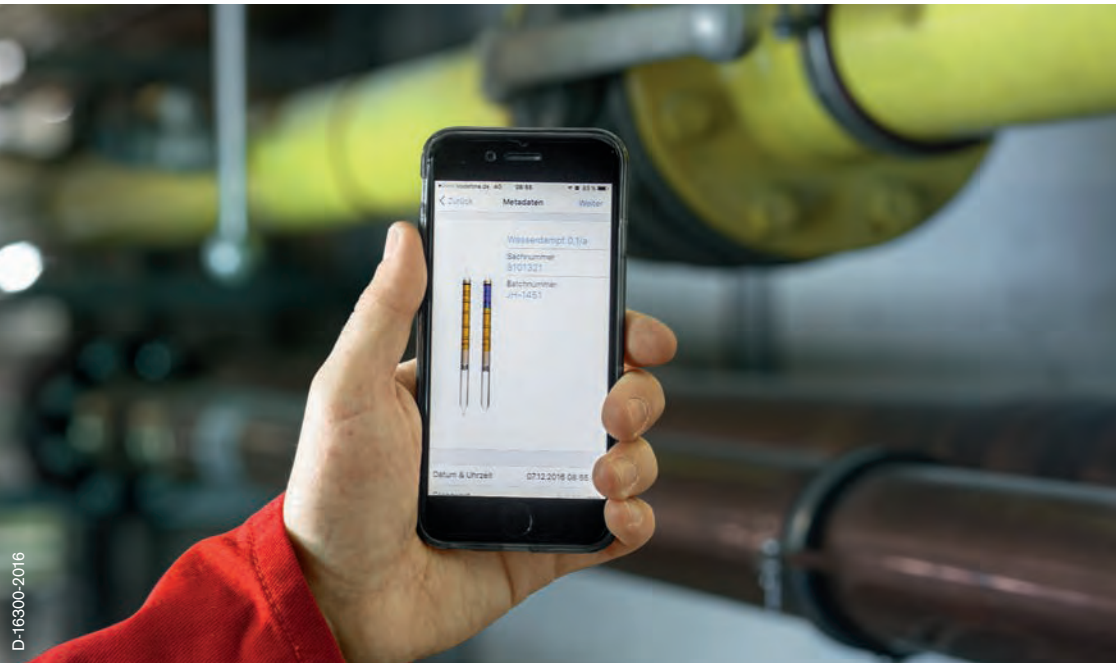

Dräger-Tubes & CMS-Handbook 18th edition

Soil, Water, and Air Investigations as well as
Technical Gas Analysis

Dräger-Tubes & CMS Handbook

Soil, Water, and Air Investigations as well as
Technical Gas Analysis

18th Edition

Dräger Safety AG & Co. KGaA,
Lübeck, 2018

This handbook is intended to be a reference source for the user. The information has been compiled to the best of our knowledge from relevant reference sources. However, the Dräger organisation is not responsible for any consequence or accident which may occur as the result of misuse or, misinterpretation of the information contained in this handbook.

The instructions for use may not always correspond to the data given in this book. For a full understanding of the performance characteristics of the measurement devices and for the use of the Dräger products only the instructions for use enclosed with the product shall apply. The user should carefully read the instructions for use prior to the use of the measurement devices.

Furthermore, the Dräger organization has attempted to provide current factual information regarding industrial hygiene standards and occupational exposure levels, but inasmuch as these standards and levels are being revised periodically, the user should consult current local, state and federal regulations.

Technical data are subject to modifications.

Publisher: Dräger Safety AG & Co KGaA

Dräger-Tube/CMS Handbook: Handbook for short term measurements
in soil, water and air investigations as well as technical gas analysis.

Lübeck, 2018

ISBN 3-926762-06-3

© 2018 Dräger Safety AG & Co. KGaA

Revalstrasse 1 | 23560 Luebeck | Germany

Printed in Germany

Editorial Date: March 2018

ISBN 3-926762-06-3

Preface

Since the last edition, a range of new developments, improvements and modifications have affected Dräger-Tubes measurement technology. The data section on the individual Dräger-Tubes and systems has been expanded and updated. Many of the pictures of the Dräger-Tubes that are described have been recreated, as it was possible to improve the color depth and color contrast of different tubes by using an optimized production method.

The design of the present 18th Edition retains the layout and structure of the previous edition.

Lübeck, March 2018

Dräger Safety AG & Co. KGaA

Table of Contents

1. General	8
1.1 Introduction to Gas Measuring	8
1.2 Concentration, Specifications, and Conversions	11
1.3 Water Vapor and Humidity	13
1.4 Information System Dräger VOICE	16
1.5 Mobile data collection with the new Dräger-Tubes App	17
2. Dräger-Tubes and Applications	19
2.1 Dräger-Tube Measurement	19
2.2 Chemical Basics – Reaction Mechanisms	24
2.3 Dräger-Tube Measurement System	27
2.4 Dräger-Tubes for Short-Term Measurements	34
2.5 Evaluation of Dräger-Tubes	37
2.6 Hot Air Probe	39
2.7 Extension Hose	40
2.8 Investigation of Compressed Air, Medical Gases, and Carbon Dioxide	41
2.9 Proposed Strategy for Determining Gas Hazards	45
2.10 Measurement of Fumigants	51
2.11 Determination of Volatile Contaminants in Liquid Samples	54
2.12 Detection of Air Flows	56
2.13 Dräger-Measurement-Systems for Long-Term Measurements	57
2.14 Expiration Date, Storage, and Disposal of Dräger-Tubes	58
2.15 Dräger-Sampling-Systems	58
2.16 Measurement of Aldehydes and Isocyanates at the Workplace	62
2.17 Quality Control for Dräger-Tubes	63
3. Dräger-Chip-Measurement-System	65
3.1 The Philosophy of the Chip-Measurement-System Dräger CMS	65
3.2 The Components of the Dräger CMS	66
3.3 The Chip	67
3.4 The Analyzer	68
3.5 The Measurement	69
3.6 The Data Recorder	71
3.7 Measuring with the Remote System	71
3.8 Validation of Third Parties	72
3.9 Technical Data Dräger CMS	74
3.10 Approvals	75

4. Overview of the Dräger-Tubes and Chip-Measurement-Systems	76
4.1 Dräger-Tube Pumps and Systems	76
4.2 Dräger-Tubes for Short-Term Measurements	77
4.3 Dräger-Tubes for Measurements in Liquid Samples	84
4.4 Dräger-Diffusion-Tubes with Direct Indication	86
4.5 Dräger-Sampling-Tubes and Systems	87
4.6 Overview of Substances for Measurement with Dräger-Sampling-Tubes and Systems	88
4.7 Dräger-Chips	96
5. Data and Tables	98
5.1 Dräger-Tube Measurement System	98
5.1.1 Explanation to the Data about Dräger-Tubes	98
5.1.2 Data about Dräger-Tubes for Short-Term Measurements	101
5.1.3 Data about Dräger Simultaneous Test Set	275
5.1.4 Data about Dräger-Tubes for Military Applications	283
5.1.5 Data about Dräger-Tubes used with Dräger Aerotest	295
5.1.6 Measuring Instructions of Contaminants in Liquids	309
5.1.7 Data about Direct Indicating Dräger Diffusion Tubes	353
5.1.8 Data about Dräger Sampling Tubes and Systems	361
5.2 Dräger- Chip-Measurement-System	374
5.2.1 Explanation to the Data about Dräger-Chips	374
5.2.2 Data about Dräger-Chips for Short-Term Measurements	375
5.3 Physical, Chemical, and Toxicological Data for selected Substances	404
5.3.1 Explanation to the Physical, Chemical, and Toxicological Data	404
5.3.2 Table of Physical, Chemical, and Toxicological Data for selected Substances	407
6. Directory of Synonyms	438

1. General

1.1 Introduction to Gas Measuring

Natural, ambient air is chemically a gas mixture that consists of 78 % nitrogen, 21 % oxygen 0.03% carbon dioxide as well as argon, helium and other rare gases in trace concentrations. In addition there is water vapor, e. g. humidity. If the concentrations of the components change, or a foreign gas is added, we no longer have natural air. When these changes occur, the potential for adverse health effects exist.

The spectrum of other so-called air components can be extremely broad. It can range from the pleasant fragrance of a good perfume to the overpowering stench of hydrogen sulfide. Likewise, the hazard of each "air pollutant" varies considerably. The type of substance, its concentration and duration of occurrence, as well as probable synergistic effects with certain gas compounds must all be considered. In addition, there are many air pollutants which cannot be perceived by human senses because they are colorless and odorless (e. g. carbon monoxide).

If the composition of the natural air changes in any way, it should be tested, to determine the substance which caused this change. Even substances with distinctive odors cannot be reliably assessed with the aid of the olfactory nerve in the nose. The olfactory nerve can become desensitized after a certain period of time or repeated exposure, making it impossible to smell even immediately dangerous concentrations. After a few hours we do not even perceive the pleasant fragrance of our own perfume and high concentrations of hydrogen sulfide escape from the sense of smell even after a very short while.

Subjectively, one persons sense of smell may be more sensitive to certain air pollutants than others. In many cases substances are noticed in very low concentrations which, even after a long-term exposure do not necessarily cause adverse health effects. In general the sense of smell is sufficient in determining the presence of air pollutants, but the need exists for an objective gas analysis method. Gas measurement serves as a technical aid and an assessment of the concentration is only possible with a gas measurement device. To determine the hazard potential of a gas it is necessary to measure its concentration and to consider the duration of exposure and other parameters such as the type of work being performed.

If only the concentration of an air pollutant is known it is difficult to evaluate the degree of the hazard. For Example, there is a degree of uncertainty regarding the health effects of cigarette smoking. The synergistic effect of the more than 800 single substances in cigarette smoke and the physiological condition of the smoker are all factors in determining the toxicological influence to the individual.

An important prerequisite to determining the potential of any gaseous air pollutants is the determination of the concentration with a suitable gas measurement device. The kind of device to be used depends on which gases have to be measured and how often. Much to the dismay of both the user and the manufacturer, there is no universal instrument which measures all gases or vapors. The variety of substances is too wide for a single technique to measure all possible air pollutants. The more chemically complex a substance is, the more complex the gas measurement technique.

It may be that more than one measurement device or measurement method may be employed, each based on different operational principles. The instrumentation industry offers various devices for this purpose which can be used, individually or in combination on the measurement task:

- flame ionization detectors
- photo ionization detectors
- gas chromatographs
- infrared spectrometers
- UV-VIS photometers
- warning devices for explosion hazards
- Dräger-Tubes
- Dräger Chip-Measurement-System
- laboratory analysis in conjunction with sampling tubes or gas wash bottles (impinger)
- mass spectrometers
- instruments with e. g. electrochemical sensors

The choice of which monitor or measurement method to use depends upon the objective. The user must evaluate the situation and determine which substances to measure, how often, etc. Each of the above mentioned devices and methods have advantages and limitations. There is no universal monitor for all possible scenarios. For the selection of a suitable measuring device and to support the user in solving measurement problems, Dräger Safety AG & Co. KGaA offers competent know-how and technical assistance. The customer / employer should carefully train the user / employee on the use of their measurement device. Any use of the measurement device without receiving prior comprehensive training can be permitted by the customer / employer to the user / employees, at the customer / employees own risk.



D-646F-2017

Photo and flame ionization detectors are distinguished by short Dräger X-am 8000

response periods but they do not offer substance selectivity. Gas chromatographs, infrared and UV-VIS photometers are very versatile but on the other hand they are comparatively expensive and require a specialist to calibrate the devices and interpret the readings correctly. Warning devices for explosion hazards like the Dräger X-am 8000 are equipped with catalytical sensors to determine explosion levels of combustible gases and vapors. For a correct function the sensors must be checked by the user using with test gases. This is the only way to achieve a reliable and correct measurement and warning against the dangers of a hazardous hazard.



Dräger-Tubes

1-394-90

Dräger-Tubes with direct reading colorimetric indication have many applications. Approximately 500 different substances can be measured with Dräger-Tubes.

Dräger-Tubes are usually capable of only being used a once may present a disadvantage. If repeated measurements of the same substance are to be performed daily, a measurement device like the Dräger Pac 6500 CO with its electrochemical sensor for the measurement of carbon monoxide is more economic than Dräger-Tubes.



Laboratory Analysis in the Dräger Analysis Service

ST-987-2004

When complex mixtures (e. g. solvent mixtures), are present, usually only a laboratory analysis will suffice. The prerequisite is that the contaminated air is trapped in a sorbent sampling tube like silica gel or activated charcoal.

After collecting the sample, analysis is performed in the laboratory with gas chromatographic methods, or sometimes by the combination of gas chromatography / mass spectroscopy.

Laboratory procedures of this kind offer particularly high selectivity, but the analysis devices are very expensive, requiring high maintenance costs and operation by specialists.

Regardless of the gas measurement device or what analysis procedure is used, it is essential that the contaminant of interest be identifiable and measurable. Apart from a few exceptions in process monitoring, it is very unlikely that concentrations of other substances can be determined by subtracting the concentration of the gas which can be identified. For example, if the oxygen concentration is below the 17 Vol. % limit, it cannot be said which substance has displaced the oxygen without further investigation. In the case of very high carbon dioxide concentrations there is the danger of suffocation; likewise if there is a leak in a gas pipeline the presence of methane poses an explosion hazard. Other

contaminants present in the ppm or ppb range would not influence the oxygen measurement enough to alert anyone to a potential hazard. Since many of the occupational exposure limits are in the range of 1 ppm or lower, the measurement by difference technique is typically inadequate.

Before each measurement an assessment of the situation should be made as to what contaminants are in question, at what locations, at what times, and so forth, according to established safety procedures. Monitoring according to established safety guidelines will help ensure safety in the workplace and effective use of monitoring equipment.

1.2 Concentration, Specifications, and Conversions

Concentrations are given as the content of a substance in a reference substance. For the measurement of contaminants in air, a concentration is used for the amount of the substance compared to the air. An appropriate engineering unit is chosen, to give simple, handy figures for indicating a concentration.

High concentrations are generally given in volume percent (Vol.-%), i.e. 1 part of a substance in 100 parts of air. Air consists of 21 Vol.-% oxygen. (i.e. 100 parts of air contain 21 parts of oxygen).

In smaller concentrations the engineering unit ppm = parts per million (mL/m^3) is used. The concentration ppm means 1 part of a substance in 1 million parts of air, ppb refers to 1 part of a substance in 1 billion parts of air.

The conversion of very small concentration units to Vol.-% is as follows:

$$1 \text{ Vol.-%} = 10,000 \text{ ppm} = 10,000,000 \text{ ppb}$$

In addition to gaseous components the air also contains solid particles or liquid droplets, called aerosols. Since an indication in volume percent is not very useful due to the small size of the droplets or particles, the concentration of the aerosols is given in mg/m^3 .

		Vol.-%	ppm	ppb
Vol.-% =	$10 \text{ L}/\text{m}^3$ $1 \text{ cL}/\text{L}$	1	10^4	10^7
ppm =	mL/m^3 $\mu\text{L}/\text{L}$	10^{-4}	1	10^3
ppb =	$\mu\text{L}/\text{m}^3$ nL/L	10^{-7}	10^{-3}	1

		g/L	mg/L	mg/m^3
g/L =	$10 \text{ L}/\text{m}^3$ $1 \text{ cL}/\text{L}$	1	10^3	10^6
mg/L =	mL/m^3 $\mu\text{L}/\text{L}$	10^{-3}	1	10^3
$\text{mg}/\text{m}^3 =$	$\mu\text{L}/\text{m}^3$ nL/L	10^{-6}	10^{-3}	1

Since each volume is related to a corresponding mass, the volume concentrations of gaseous substances can be converted into mass per unit volumes and vice versa. These conversions must be done at a specified temperature and pressure since the gas density is a function of temperature and pressure. For measurements at work places, the reference parameters are 20 °C and 1013 hPa.

Conversion from mg/m³ to ppm

$$c \text{ [ppm]} = \frac{\text{mole volume}}{\text{molar mass}} \cdot c$$

The mole volume of any gas is 24.1 L/mole at 20 °C and 1013 hPa, the molar mass (molecular weight) is gas specific.

Example for acetone:

mole volume	24.1	L/mole
molar mass	58	g/mole
assumed concentration	876	mg/m ³

$$c \text{ [ppm]} = \frac{24.1}{58} \cdot 876$$

Concentration in ppm: $c = 364 \text{ ppm or mL/m}^3$.

Conversion from ppm to mg/m³

$$c \text{ [mg/m}^3\text{]} = \frac{\text{molar mass}}{\text{mole volume}} \cdot c$$

with the assumed concentration of 364 ppm it is:

$$c \text{ [mg/m}^3\text{]} = \frac{58}{24.1} \cdot 364$$

Concentration in mg/m³ : $c = 876 \text{ mg/m}^3$.

1.3 Water Vapor and Humidity

Water vapor in the atmosphere is commonly called humidity. There are many sources for it, after all the surface of the earth consists of two thirds water. Humans also "produce" water vapor as a metabolic product with each breath that is exhaled.

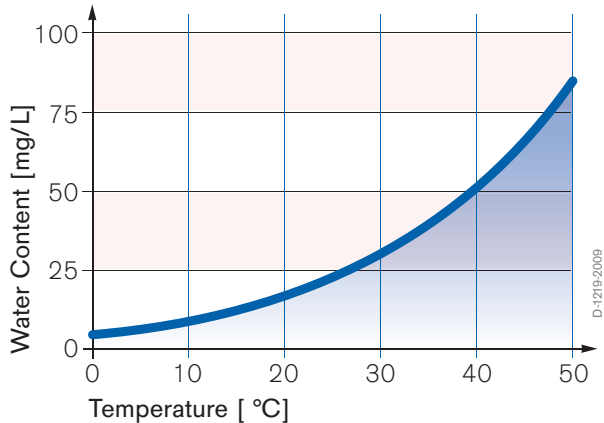

The maximum water vapor content of the air depends on temperature, i. e. the figures of relative humidity are always to be considered in reference to temperature. To convert relative humidity into absolute humidity as a function of temperature, the above diagram or the following formula can be used. Using a pocket calculator a conversion can be done:

$$Y = 3.84 \cdot 10^{-6} \cdot \vartheta^4 + 2.93 \cdot 10^{-5} \cdot \vartheta^3 + 0.014 \cdot \vartheta^2 + 0.29 \cdot \vartheta + 4.98$$

With y = maximum absolute humidity in mg H₂O / L and ϑ = temperature in °C. This formula is valid for the temperature range of 0 to 100 °C.

Example: The absolute humidity at $t = 25$ °C is needed. Using the formula the result is $y = 22.94$ mg H₂O / L. The result indicates that at 25 °C the maximum absolute humidity is 22.94 mg/L; that corresponds to a relative humidity of 100 % at the same temperature.

Similarly, every other absolute humidity at this temperature can be calculated, e. g. 50 % relative humidity at 25 °C equals 11.47 mg H₂O / L etc. If the relative humidity and the corresponding temperature are known, the absolute humidity can be calculated using the above formula.

A general statement about the effect of humidity on detector tube indications cannot be made. Some tubes, like hydrogen sulfide, need only a minimum amount of water vapor since the indicating reaction of this tube is an ion reaction. Also, because of the extraordinarily low solubility of metal sulfides, the upper limit of the humidity is not important with these tubes. However, with other types of tubes the reaction system can possibly be diluted with high humidity. Therefore, the limits of the humidity given for the respective detector tubes must be observed to prevent erroneous measurements.

As a general rule the upper and lower humidity limits are given in the instructions for use and in this handbook. When in doubt, measure the humidity using a water vapor Dräger-Tube.

mg/l	Relative humidity in %																																			
	29	27	26	24	23	21	20	19	18	17	16	15	14	13	12	11	10	10	9	9	8	8	7	7	7	6	6	6	5	5	5	4				
2	44	41	38	36	34	32	30	28	26	25	23	22	21	19	18	17	16	15	14	13	12	11	10	10	9	9	8	8	7	7	7	5	5	4		
3	59	55	51	48	45	43	40	37	35	33	31	29	28	26	25	23	22	21	19	18	17	16	15	14	13	12	11	10	10	9	8	7	7			
4	73	68	64	60	57	53	50	47	44	41	39	37	34	32	31	29	27	26	24	23	22	20	19	18	17	16	15	14	13	12	11	10	9	9		
5	88	82	77	72	68	64	60	56	53	50	47	44	41	39	37	35	33	31	29	27	26	25	23	22	21	20	19	18	17	16	15	14	13	11		
6	96	90	84	79	74	70	65	61	58	55	51	48	45	43	40	38	36	34	32	30	29	27	26	24	23	22	21	20	19	18	17	16	15	14	13	
7	—	—	—	—	—	—	—	—	—	—	—	—	—	—	—	—	—	—	—	—	—	—	—	—	—	—	—	—	—	—	—	—	—	—	—	
8	—	—	—	—	—	—	—	—	—	—	—	—	—	—	—	—	—	—	—	—	—	—	—	—	—	—	—	—	—	—	—	—	—	—	—	
9	—	—	—	—	—	—	—	—	—	—	—	—	—	—	—	—	—	—	—	—	—	—	—	—	—	—	—	—	—	—	—	—	—	—	—	
10	—	—	—	—	—	—	—	—	—	—	—	—	—	—	—	—	—	—	—	—	—	—	—	—	—	—	—	—	—	—	—	—	—	—	—	
11	—	—	—	—	—	—	—	—	—	—	—	—	—	—	—	—	—	—	—	—	—	—	—	—	—	—	—	—	—	—	—	—	—	—	—	
12	—	—	—	—	—	—	—	—	—	—	—	—	—	—	—	—	—	—	—	—	—	—	—	—	—	—	—	—	—	—	—	—	—	—	—	
13	—	—	—	—	—	—	—	—	—	—	—	—	—	—	—	—	—	—	—	—	—	—	—	—	—	—	—	—	—	—	—	—	—	—	—	—
14	—	—	—	—	—	—	—	—	—	—	—	—	—	—	—	—	—	—	—	—	—	—	—	—	—	—	—	—	—	—	—	—	—	—	—	—
15	—	—	—	—	—	—	—	—	—	—	—	—	—	—	—	—	—	—	—	—	—	—	—	—	—	—	—	—	—	—	—	—	—	—	—	—
16	—	—	—	—	—	—	—	—	—	—	—	—	—	—	—	—	—	—	—	—	—	—	—	—	—	—	—	—	—	—	—	—	—	—	—	—
17	—	—	—	—	—	—	—	—	—	—	—	—	—	—	—	—	—	—	—	—	—	—	—	—	—	—	—	—	—	—	—	—	—	—	—	—
18	—	—	—	—	—	—	—	—	—	—	—	—	—	—	—	—	—	—	—	—	—	—	—	—	—	—	—	—	—	—	—	—	—	—	—	—
19	—	—	—	—	—	—	—	—	—	—	—	—	—	—	—	—	—	—	—	—	—	—	—	—	—	—	—	—	—	—	—	—	—	—	—	—
20	—	—	—	—	—	—	—	—	—	—	—	—	—	—	—	—	—	—	—	—	—	—	—	—	—	—	—	—	—	—	—	—	—	—	—	—
21	—	—	—	—	—	—	—	—	—	—	—	—	—	—	—	—	—	—	—	—	—	—	—	—	—	—	—	—	—	—	—	—	—	—	—	—
22	—	—	—	—	—	—	—	—	—	—	—	—	—	—	—	—	—	—	—	—	—	—	—	—	—	—	—	—	—	—	—	—	—	—	—	—
23	—	—	—	—	—	—	—	—	—	—	—	—	—	—	—	—	—	—	—	—	—	—	—	—	—	—	—	—	—	—	—	—	—	—	—	—
24	—	—	—	—	—	—	—	—	—	—	—	—	—	—	—	—	—	—	—	—	—	—	—	—	—	—	—	—	—	—	—	—	—	—	—	—
25	—	—	—	—	—	—	—	—	—	—	—	—	—	—	—	—	—	—	—	—	—	—	—	—	—	—	—	—	—	—	—	—	—	—	—	—
26	—	—	—	—	—	—	—	—	—	—	—	—	—	—	—	—	—	—	—	—	—	—	—	—	—	—	—	—	—	—	—	—	—	—	—	—
27	—	—	—	—	—	—	—	—	—	—	—	—	—	—	—	—	—	—	—	—	—	—	—	—	—	—	—	—	—	—	—	—	—	—	—	—
28	—	—	—	—	—	—	—	—	—	—	—	—	—	—	—	—	—	—	—	—	—	—	—	—	—	—	—	—	—	—	—	—	—	—	—	—
29	—	—	—	—	—	—	—	—	—	—	—	—	—	—	—	—	—	—	—	—	—	—	—	—	—	—	—	—	—	—	—	—	—	—	—	—
30	—	—	—	—	—	—	—	—	—	—	—	—	—	—	—	—	—	—	—	—	—	—	—	—	—	—	—	—	—	—	—	—	—	—	—	—

100% Saturation	Air temperature																																																																																																																																																																																																																																																																																																																																																																																																																																																																																																																																																																																																																																										
	5	6	7	8	8	9	10	11	12	13	14	15	16	17	18	19	20	21	22	23	24	25	26	27	28	29	30	31	32	33	34	35	36	37	38°C																																																																																																																																																																																																																																																																																																																																																																																																																																																																																																																																																																																																								
5.9	7.3	7.8	8.3	8.8	9.4	10.0	10.7	11.4	12.1	12.8	13.6	14.5	15.4	16.3	17.3	18.8	19.4	20.6	21.8	23.0	24.4	25.8	27.2	28.7	30.3	32	34	35	37	39	41	44	46	48	50	52	54	56	58	60	61	63	65	66	68	70	71	73	75	77	79	81	83	85	87	89	91	93	95	97	99	100	102	104	106	108	110	112	114	116	118	120	122	124	126	128	130	132	134	136	138	140	142	144	146	148	150	152	154	156	158	160	162	164	166	168	170	172	174	176	178	180	182	184	186	188	190	192	194	196	198	200	202	204	206	208	210	212	214	216	218	220	222	224	226	228	230	232	234	236	238	240	242	244	246	248	250	252	254	256	258	260	262	264	266	268	270	272	274	276	278	280	282	284	286	288	290	292	294	296	298	300	302	304	306	308	310	312	314	316	318	320	322	324	326	328	330	332	334	336	338	340	342	344	346	348	350	352	354	356	358	360	362	364	366	368	370	372	374	376	378	380	382	384	386	388	390	392	394	396	398	400	402	404	406	408	410	412	414	416	418	420	422	424	426	428	430	432	434	436	438	440	442	444	446	448	450	452	454	456	458	460	462	464	466	468	470	472	474	476	478	480	482	484	486	488	490	492	494	496	498	500	502	504	506	508	510	512	514	516	518	520	522	524	526	528	530	532	534	536	538	540	542	544	546	548	550	552	554	556	558	560	562	564	566	568	570	572	574	576	578	580	582	584	586	588	590	592	594	596	598	600	602	604	606	608	610	612	614	616	618	620	622	624	626	628	630	632	634	636	638	640	642	644	646	648	650	652	654	656	658	660	662	664	666	668	670	672	674	676	678	680	682	684	686	688	690	692	694	696	698	700	702	704	706	708	710	712	714	716	718	720	722	724	726	728	730	732	734	736	738	740	742	744	746	748	750	752	754	756	758	760	762	764	766	768	770	772	774	776	778	780	782	784	786	788	790	792	794	796	798	800	802	804	806	808	810	812	814	816	818	820	822	824	826	828	830	832	834	836	838	840	842	844	846	848	850	852	854	856	858	860	862	864	866	868	870	872	874	876	878	880	882	884	886	888	890	892	894	896	898	900	902	904	906	908	910	912	914	916	918	920	922	924	926	928	930	932	934	936	938	940	942	944	946	948	950	952	954	956	958	960	962	964	966	968	970	972	974	976	978	980	982	984	986	988	990	992	994	996	998	1000	1002	1004	1006	1008	1010	1012	1014	1016	1018	1020	1022	1024	1026	1028	1030	1032	1034	1036	1038	1040	1042	1044	1046	1048	1050	1052	1054	1056	1058	1060	1062	1064	1066	1068	1070	1072	1074	1076	1078	1080	1082	1084	1086	1088	1090	1092	1094	1096	1098	1100	1102	1104	1106	1108	1110	1112	1114	1116	1118	1120	1122	1124	1126	1128	1130	1132	1134	1136	1138	1140	1142	1144	1146	1148	1150	1152	1154	1156	1158	1160	1162	1164	1166	1168	1170	1172	1174	1176	1178	1180	1182	1184	1186	1188	1190	1192	1194	1196	1198	1200	1202	1204	1206	1208	1210	1212	

1.4 Information System Dräger VOICE

The Dräger VOICE database provides up-to-date information about more than 1,600 hazardous substances and recommendations for the products offered by Dräger to measure these hazardous substances and to protect oneself against them. It also includes instructions on how to handle and use the products recommended. The program starts with a search template that searches the requested hazardous substance by entering a chemical name, CAS, EINECS or UN number, the chemical formula or one of the substance's synonyms. Detailed continuously updated information about the substance selected can be retrieved such as:

- German and international limit values
- various physical-chemical properties such as molar mass, density, melting point, boiling point and explosion limits in air
- markings such as Global harmonized System of Classification, Kemlerzahl, regulatory and safety data, and danger notices
- synonyms

The Dräger-Tubes that are recommended for detection of the selected substance are categorised in short-term and long-term tubes and Chip-Measurement-System. Usually the following information about the products is available:

- picture and enlarged view
- order number
- list of measuring ranges for different measuring instructions and cross sensitivities
- related products

Dräger VOICE® App

The Dräger VOICE® App is now available as App for iOS and Android – and you can use them on- and offline. The App is really easy to use and allows fast search and analyzation of up to three substances at once.

1.5 Mobile data collection with the new Dräger-Tubes App



D-180313-2016

Dräger-Tubes App

From now on, gas measurements with Dräger-Tubes can be documented digitally. To this end, Dräger is providing a free app for iOS and Android. The cumbersome manual filling-in of data into paper-bound forms will thus no longer be necessary. Instead, this can be done via smartphone in a few steps and in 17 languages: Scan the tube, perform the measurement, capture the data and send the measurement protocol off via WhatsApp, email or another messenger service.

Dräger-Tubes are used in many areas such as for example manufacturing, fire-fighting, mining and shipping. Wherever it is essential to determine the concentration of a specific substance swiftly and reliably. However, the measuring results are still entered manually into a protocol.

This entails a lot of maintenance effort, slows down processes and may even lead to errors.

The Dräger-Tubes App is now making the entire measuring and documenting process a lot more convenient. Especially in cases where an environment is to be released for safe access, great benefit is provided by the app. For in this way, measurement data can be transmitted much faster for assessment by a remote safety engineer, who is then able to make his recommendations for action without delay.

This is how the app works

Before making the measurement, the barcode on the packaging of the Dräger-Tubes is scanned using the smartphone. The app identifies the tube and automatically loads the appropriate data into the provided protocol. Thus, all the person entrusted with making the measurement has to do is read the value from the tube and enter it into the app. In addition, it is possible to attach photos or to capture position, temperature and air humidity data for enhanced documentation.

DCI-1133/2017



App Symbol

Dräger-Tubes® App for iOS



Dräger-Tubes® App for Android



Thanks to the personalized user profile feature and utilization of favorites, the data can then be made available with a single click. Constantly recurring entering of data will thus be a thing of the past. Additionally, the measured values can be displayed and evaluated graphically, if desired.

The app reliably stores all protocols in the memory of the mobile phone. For comprehensive documentation, it is also possible to combine individual protocols into reports. Via email, WhatsApp or other messenger services, the data can be transmitted quickly and with ease.

2. Dräger-Tubes and Applications

2.1 Dräger-Tube Measurement

Today, detector tubes are one of the classical measurement techniques of gas analysis. The first detector tube patent appeared in America in 1919. Two Americans, A. B. Lamb and C. R. Hoover, impregnated pumice with a mixture of iodine pentoxide and sulfuric acid. This preparation, which they put in a vial, became the first chemical sensor for measuring or rather detecting carbon monoxide. Before this early detector tube, canaries were used as "sensors" in coal mining.

This first detector tube was only used for qualitative detection of the presence of carbon monoxide, quantitative measurement was not yet possible. Today the Dräger-Tubes provide quantitative results with a high degree of accuracy and selectivity. Since the development of the first Dräger-Tube, more than 75 years ago, Dräger has expanded the product line and Dräger-Tubes belong to the traditional products of Dräger.

In comparison with the first detector tube patent, the basic shape and structure of a tube may appear not to have changed; however, closer inspection reveals the contents have changed dramatically. What is a Dräger-Tube? Simplistically, it is a vial which contains a chemical preparation that reacts with the measured substance by changing color. To achieve the normal shelf life of 2 years the tube tips are fused at both ends. Thus, the vial provides an inert package for the reagent system. Most of the Dräger-Tubes are scale tubes and it should be emphasized that the length-of-stain discoloration is an indication of the concentration of the measured substance.

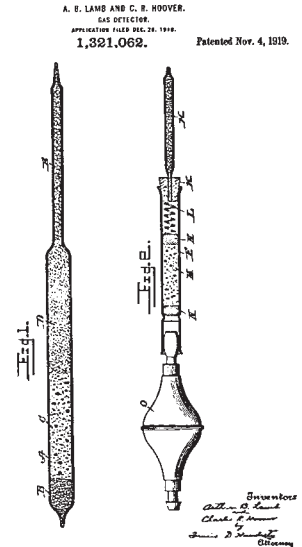

Patent drawing by Lamb and Hoover



Gas Sampling Pump 1950

The printed scale allows a direct reading of the concentration. Thus, calibration by the user is not necessary. Of course the length-of-stain discoloration does not correspond to the concentration as a direct measure but is, strictly speaking, a measure of the mass reaction of the air contaminant with the Dräger-Tube preparation. Since the information that 25 mg of nitrogen dioxide has reacted is not practical information for the workplace, the calibration scale is prepared in the engineering units ppm or volume percent.

For many years, only a few gases could be measured with detector tubes. The main area of application was and still is the measurement of air contaminants in the workplace, in the concentration range of the occupational exposure limits. Decreasing occupational exposure limits have made it necessary to develop more sensitive Dräger-Tubes. In addition, efforts to better understand the exposure profile in the workplace have resulted in special Dräger-Tubes for long-term measurement which determine time weighted averages over given time periods.



Dräger-Tube
Nitrogen Dioxide 2/c

Dräger-Tubes can be schematically classified utilizing the following criteria:

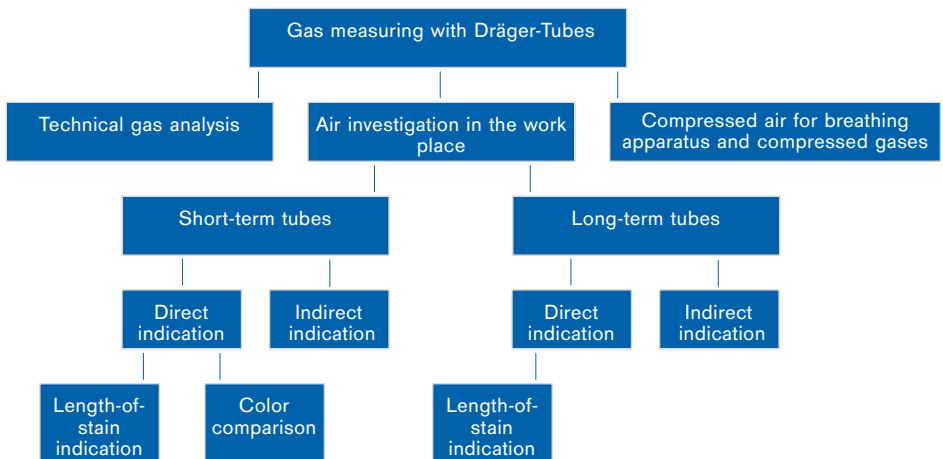

Distinction is made according to the fundamentally different areas of application:

- **Air investigation in the workplace**

Measurements in the range of the occupational exposure limits.

- **Technical gas analysis**

Dräger-Tube measurements in the area of emission concentrations.

- **Compressed air for breathing apparatus and compressed gases**

Specially calibrated Dräger-Tubes used with the Dräger Aerotest to determine the quality of compressed breathing air. The typical contaminants are CO, CO₂, water and oil.

Short-term tubes are designed for on-the-spot measurements at a particular location over a relatively short time period. Short-term tube measurements may last from 10 seconds to 15 minutes or so depending on the particular Dräger-Tube and sampling pump. Some applications for short-term tubes are the evaluation of concentration fluctuations in the workplace, the measurement of contaminants in the workers' breathing zone, the investigation of confined spaces (e. g. grain silos, chemical tanks, sewers) prior to entry and to check for gas leaks in process pipelines.

Suitable pumps for Dräger short-term tubes are:

- **Dräger-Tube pump accuro**

- **Dräger X-act 5000, ex-approved, automatic Dräger-Tube pump**

For long-term measurements Dräger-Diffusion-Tubes with direct indication and sampling tubes and systems are available. Long-term measurements with diffusion tubes provide integrated measurements that represent the average concentration during the sampling period. Normally the measurements are performed between one and eight hours. These tubes can be used economically as personal monitors or area monitors to determine the weight average concentration. In contrast to short-term tubes, no pump is necessary for sampling with these measurement devices. The contaminant molecules automatically move into the tube or onto the badge, according to Fick's First Law of Diffusion.

The driving force for this movement of the contaminant molecules is the concentration differential between the ambient air and the inside of the tube. Since the diffusion tubes do not require a pump, they are particularly effective as personal gas monitors.

When complex substances or components that are chemically very similar, like methanol, ethanol, and propanol are present, direct reading Dräger-Tubes approach their limits of use. A colorimetric reaction system based on a iodine pentoxide cannot distinguish between aliphatic hydrocarbons and indicates the sum of the concentration. In this example, the aliphatic hydrocarbons are indicated with almost the same sensitivity. Solvents usually consist of three to five different components, all chemically very similar. The use of a single Dräger-Tube in this case would not yield reliable results without any previous knowledge because of possible and probable cross sensitivities. In cases such as these, a sample should first be collected using a sampling tube which is then sent to a laboratory for analysis. The analysis will be conducted using gas chromatography or a photometric analysis technique.



ST-1350-2004

Direct reading diffusion tube with holder

Dräger sampling tubes contain coconut shell charcoal, different types of silica gel, or molecular sieve. The sampling tubes do not produce a color change and therefore can be described as indirect indicators. The sampling of isocyanates is accomplished using a specially prepared Dräger sampler which is analyzed after sampling via HPLC procedures.

After the analysis with sorbent sampling tubes it is often possible for subsequent measurements to be performed economically with direct reading short-term or long-term tubes targeted for particular components of a mixture.



ST-174-2004

Dräger diffusion sampler ORSA

In order to choose the best Dräger-Tube for the particular application, an assessment of the measurement with regard to the ambient conditions and the possible limits of use is very important. This assessment ensures that the advantage of the Dräger-Tube method does not turn into a disadvantage due to unforeseen cross sensitivities.

In any case, although the Dräger-Tube is an easily operated gas measurement method, it belongs in the hands of specialists. People trained in the field of industrial hygiene should be capable of determining the time and place to monitor, to recognise possible cross sensitivities, and to interpret measurement results correctly.

For all gas analysis tasks Dräger provides competent and extensive service beyond the initial sale of its products. This service includes:

- free consultation for specific questions on measurements with Dräger-Tubes,
- ¹⁾analysis of loaded samplers in the laboratory of the Dräger analysis service
- ¹⁾measurement and sampling on site with analysis in the laboratory of the Dräger analysis service according to official regulations,
- Internet information system VOICE: www.draeger.com/voice
- Seminars about special subjects

¹⁾This service is based in Germany.

2.2 Chemical Basics – Reaction Mechanisms

The basis of any direct reading Dräger-Tube is the chemical reaction of the measured substance with the chemicals of the filling preparation. Since this reaction leads to a discoloration, the Dräger-Tubes can also be called colorimetric chemical sensors. The substance conversion in the Dräger-Tube is proportional to the mass of the reacting gas. Generally it is possible to indicate this substance conversion as a length-of-stain indication. When a length-of-stain indication is not practical, the alternative is a Dräger-Tube with the indication based on interpretation of color intensity according to a given reference standard or set of standards.

The filling layers of Dräger-Tubes are comprised of different reagent systems. There are essentially 14 reagent systems used in Dräger-Tubes and in some cases these reagents are combined in the same tube to give desired effects. For the Dräger-Tube user the selectivity of the individual tube is very significant. The spectrum of selectivity of Dräger-Tubes ranges from the substance selective Dräger-Tubes for carbon dioxide to tubes which are selective to substance groups (e. g. chlorinated hydrocarbons), to the class selective Dräger-Tube like the Polyttest tube which indicates many easily oxidizable substances. The Dräger-Tube user has many options available when using Dräger-Tubes. This handbook is intended to help sort out those options.

One of the classic Dräger-Tube reactions is the conversion of iodine pentoxide under acidic conditions to iodine by reaction with carbon monoxide. While it is basically a class selective reaction for the measurement of easily oxidizable substances, the selectivity can be increased by suitable prelayers:

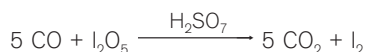

Precipitation reactions of metal salts are the basis of hydrogen sulphide tubes. Metal salts react with hydrogen sulphide and form slightly soluble metal sulphides. This is a fast ion reaction which is nearly independent of the flow rate through the Dräger-Tube. In order to make this reaction occur, a small amount of water, i.e. humidity, is necessary:

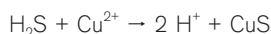

Nitrogen dioxide and elementary halogens react with aromatic amines by forming intensely colored compounds:



Since chlorinated hydrocarbons are not indicated by direct colorimetric reaction, an oxidative cleavage of the molecule is necessary as a first step. This reaction is done with potassium permanganate, which forms elementary chlorine. The chlorine then reacts with the reagent preparation in the indicating layer to produce the colorimetric reaction product.

The measurement of carbon dioxide is done by oxidation of hydrazine hydrate in the presence of crystal violet as an oxidation-reduction (redox) reaction:



Typically carbon dioxide will be present at a substantially higher concentration than any potentially cross sensitive substances, therefore this reaction is very selective. Possible interferences by hydrogen sulphide and sulfur dioxide are not expected since these interferences can only occur with unusually high concentrations.

Another large group of Dräger-Tube reactions is based on pH indicators, for example:



This type of reaction is valid for basic as well as acid gases.

Compounds containing the $\text{C}\equiv\text{N}$ -group are measured using multiple stage reactions. In the case of acrylonitrile, the first step is a oxidation. In the next step the cyanide ion reacts with mercury chloride to form hydrochloric acid and undissociated mercury cyanide. The hydrochloric acid is indicated in the last partial step of this complex reaction system by means of a pH indicator. Suitable prelayers are used to ensure a selective measurement. A similar reaction principle is also used in the most sensitive hydrogen phosphide (i. e. phosphine) tubes, Phosphine 0.01/a. The hydrogen phosphide also reacts with mercury chloride, but in this case yields mercury phosphide and hydrochloric acid. Again, the hydrochloric acid is indicated by means of pH-indicator.

Most hydrides of the elements from group III or V of the periodic table (e.g. borane or arsine), react because of their reducing characteristics with gold salts by forming elemental gold.

Aromatics condense under strongly acidic conditions with formaldehyde to form intensely colored quinoid compounds with different molecular structures.

Each of these reaction partners can be measured on this basis; aromatics like benzene and xylene as well as formaldehyde. For ethylene oxide and ethylene glycol an additional oxidation reaction is necessary, in which both substances are converted into formaldehyde.

The oxidation effect which sulfur dioxide has on iodine complexes (i.e. iodine with starch) results in a bleaching or discoloration of the colored indicator to a neutral white. This reaction is the basis of several Dräger-Tubes for sulfur dioxide.

Substituted aromatic amines react relatively selectively with acetic chlorides and phosgene, where the latter can be seen as dichloride of the carbonic acid. Carbon tetrachloride is oxidised by a strong oxidation agent into phosgene, so that this type of reaction is also suitable for the measurement of carbon tetrachloride.

The oxidation reaction of C=C double bonds with potassium permanganate is the basic reaction of the Dräger-Tubes for the measurement of olefins (i.e. alkenes). Other substances which are oxidised by permanganate (e.g. perchloroethylene) will also be indicated.

Another reduction reaction of metal salts permits the measurement of ethylene and some acrylates. Molybdate salts show an intensive discoloration from light yellow to dark blue when reduced from the highest oxidation stage to a lower one.

Substance selective reactions which have not been mentioned include:

- ketone detection with hydrazine derivatives,
- oxidation of titanium (III) salts by oxygen,
- nickel detection by dimethylglyoxime.

The limits of the gas detection method must be considered when attempting to conduct an analytical determination. It is important with regard to the selectivity to know about potential cross sensitivities. Considering the exhaustive list of potential chemical substances, it is not possible to list all potential interferences. When questions about Dräger-Tubes arise, they should be directed to the local Dräger subsidiary or distributor.

2.3 Dräger-Tube Measurement System

The Dräger-Tube measurement system consists of a Dräger-Tube and a Dräger-Tube pump. Each Dräger-Tube contains a very sensitive reagent system that produces accurate readings when the technical characteristics of the gas detector pump precisely match the reaction kinetics of the reagent system in the tube. Therefore, a gas detector pump, delivering the correct volume must also pull the sample through the Dräger-Tube at the proper rate. These requirements are referenced in international as well as national detector tube standards or norms which require or recommend that detector tubes be used with a matching gas detector pump from the same manufacturer.

Different Dräger-Tube pumps and Dräger-Tubes are used for the Dräger-Tube measurement system. Dräger short-term tubes and the Dräger-Tube pumps are matched with each other at the factory. They form one unit. Using other pumps with Dräger short-term tubes or other short-term detector tubes with Dräger-Tube pumps can impair the proper function of the measurement system. To get accurate results with this system, each type of Dräger-Tube is calibrated in batches, along with a Dräger-Tube pump. If short-term detector tubes and pumps from different manufacturers are used, there is no guarantee that the detector tube measurement system will perform as described in the instructions for use, and it can lead to significant discrepancies in the results.

Following examination by the German Institute for Occupational Safety and Health (IFA), the Dräger-Tube pump *accuro*, for example, complies with the requirements of DIN EN 1231.

Dräger-Tube pumps

Dräger-Tube pumps can be used for short-term measurements and sample taking. Short-term measurements are on-the-spot measurements, e. g. the evaluation of concentration fluctuations, release measurements, worst case measurements etc. With a sample taking, first of all the substances to be measured are collected on a suitable medium, e. g. activated charcoal, silica gel etc. First, the air to be evaluated is drawn over the respective medium - normally at a defined volume flow (= flow rate) for a specified duration. Then, the substances collected on the medium by adsorption or chemisorption are analyzed qualitatively and quantitatively in the laboratory by means of analytical methods such as gas chromatography (GC), high performance liquid chromatography (HPLC), UV-VIS photometry or IR spectroscopy.

The following Dräger-Tube pumps are available for these measurements:

- **Dräger *accuro*, Dräger-Tube hand pump**
- **Dräger X-act 5000, ex-approved automatic Dräger-Tube pump**

Basically all Dräger-Tube pumps are to be used according to the appropriate instructions for use.

Dräger-Tube pump *accuro*

The Dräger-Tube pump *accuro* is a bellows pump. It can easily be operated with one hand and draws in 100 ml per stroke. When measuring, the pump body (bellows) is pressed together completely. This corresponds to one "stroke". During the stroke the air contained in the pump chamber escapes through the exhaust valve. The suction process runs automatically after the bellows are set free. The exhaust valve is closed during the opening phase of the bellows so that the gas sample flows through the connected Dräger-Tube into the pump. After the complete opening of the pump body into its original position the suction process is finished. The end of stroke is visible by a pressure-controlled end of stroke indication, located in the pump head. An internal scissor mechanism built into the Dräger *accuro* pump bellows provides parallel compression of the pump and an automatic stroke counter which is integrated in the pump head records the number of strokes.

The Dräger-Tube pump accuro is independent of external energy sources. Therefore, there are no usage restrictions in areas of explosion hazard.



ST-2436-2003

Dräger-Tube pump accuro

Technical data	Dräger-Tube pump accuro
Application	For short-term measurements with a small numbers of strokes
Design	Hand-operated bellows pump, one-handed operation
Number of Strokes	1 - 50 strokes and higher
Stroke volume	100 mL ($\pm 5\%$)
Dimensions (H x W x D)	approx. 85 x 170 x 45 mm
Weight	approx. 250 g
Protection class	(not required)
Battery	(not required)

Tube pump Dräger X-act 5000

Dräger X-act 5000 is an ex-approved automatic tube pump for the measurement or sample taking of gases, vapors and aerosols. The Dräger X-act 5000 is based on a completely new pump concept. The key principle is the electronic pump control for using Dräger short-term tubes and to perform sample taking with sampling tubes and systems. This pump control provides the required flow characteristics of the Dräger short-term tubes. Compared to the Dräger accuro hand pump, this new concept reduces the average measurement time of the Dräger short-term tubes with higher numbers of strokes. For a sample taking all parameters can be set directly. The internal pump is also designed to use extension hoses up to a length of 30 meters.

All components of the pump are built in a robust housing. The components of the pump are corrosion resistant and the pump is additionally equipped with an internal user



Tube pump Dräger X-act 5000

D-12080-2010

replaceable SO₃ filter which traps sulfur trioxide aerosols protecting the pump for up to two years. The two-part display (segment and matrix part) has a bright backlight to enable the use of the pump under poor lighting conditions. Dräger-Tubes, sampling tubes and systems and accessories can easily be connected.

A simple and intuitive menu structure provides the user efficient operation. After it is switched on, a startup screen appears and an automatic self-test is conducted. After the startup procedure, the user is prompted to carry out a leak test. After this test is carried out or skipped, the various operating modes are shown. The following operating modes are available:

- Measurement with short-term tubes
 - Measurement in air
 - Barcode operation in air
 - Manual operation in air
 - Measurement in technical gases
- Sample taking

To support a convenient operation a barcode reader is integrated in the Dräger X-act 5000. If the "Barcode operation in air" mode is selected, a barcode will be scanned using the barcode reader of the device to transfer the relevant measuring data into the pump. This barcode is printed on the label of the backside of the Dräger short-term tube box. Simply sliding this barcode over the barcode reader of the pump automatically transfers the required parameters into the pump. The transferred data will be indicated on the display:

- Part number of the Dräger-Tube
- Name of the substance to be measured
- Measuring range(s)
- Number of strokes for the respective measuring range
- Additional information, if applicable



The Dräger short-term tubes are calibrated for the measurements in ambient air. For measurements in technical gases the different viscosity of the technical gas, compared to the viscosity of ambient air, has to be taken into consideration. In the operating mode "Measurement in technical gases" the required flow rate is adjusted by the pump. Therefore the display prompts the user to prepare the measurement with an additional operating step.

Once measuring has finished, the measurement result can be read directly from the tube. Directly setting the volume flow (= flow rate) and the duration of the sample taking reduces the preparation time for a sample taking accordingly. The Dräger X-act 5000 automatically adjusts the set flow rate. An additional adjustment of the system using an external flow meter is not necessary. After setting the sampling time the pump can immediately be started. At the end of the set sampling time, the pump will stop automatically. The set data, the elapsed time, and the pumped volume will be indicated on the display.

The Dräger X-act 5000 is shipped from the factory with the display in English. The menu language can be changed from a password-protected menu. Other languages are available. Recurring operating modes and other necessary functions can be set or selected in order to customize operation for the respective application.

Technical data	Dräger X-act 5000
Application	For short-term measurements with higher numbers of strokes and sample taking with sampling tubes and systems.
Design	Menu-driven, automatic pump
Number of strokes	adjustable, 1 - 199 strokes
Stroke volume	100 ml (\pm 5%)
Dimensions (H x W x D)	approx. 175 x 230 x 108 mm
Weight	approx. 1.6 kg (without battery pack)
Protection class	Ex-approved IP 64
Battery packs	NiMH Battery, T4, 7,2 V, 1500 Ah (charging time < 4 h) Alkaline Battery Pack, T4, 6 AA batteries, (see Instructions for use)
Barcode reader	built-in barcode reader with Class 3R

Functional capability of Dräger-Tube pumps

To help ensure precise measurement results, it is particularly important to confirm that the pump is operating properly. Short-term pumps should be checked before each measurement for leaks and suction capacity according to the operating manual. In addition, after a measurement short-term pumps should be flushed with clean air by performing several strokes without a Dräger-Tube in the pump. This purges the pump of reaction products which enter the bellows due to the reaction in the tube.

Inspection of the Functional capability using the example of Dräger accuro

Insert an unopened Dräger-Tube and squeeze the pump completely.

After releasing the position of the pump body should not change within one minute.

Squeeze the pump completely.

After releasing, the pump must open instantly.

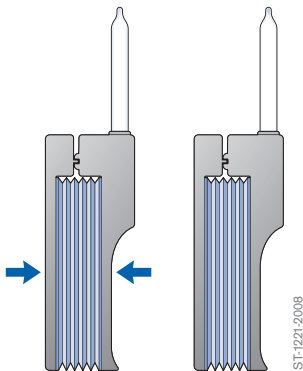

Quick test to check bellows pump for leaks

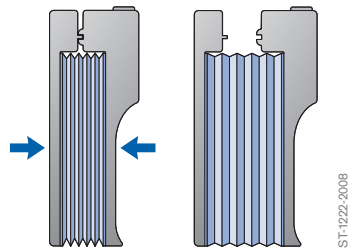

Quick test to evaluate the suction capacity of the bellows pump

2.4 Dräger-Tubes for Short-Term-Measurements

Short-term tubes are intended for the measurement of momentary concentrations. The duration of a short-term measurement is usually in the range of 10 seconds to 15 minutes. The measured value shows the actual concentration during the time period covered by the test.

The design of the short-term tube depends on the measurement task, particularly on the substance to be measured and the concentration range to be determined. There are several types of Dräger short-term tubes:

- tubes with a single indication layer,
- tubes with one or more pre-layers plus an indication layer,
- combination of two tubes,
- tubes with connecting hoses,
- tubes with a built in reagent ampoule,
- tubes for simultaneous measurement

Short-term tubes with a single indication layer

The whole filling layer in these tubes serves as the indication layer.

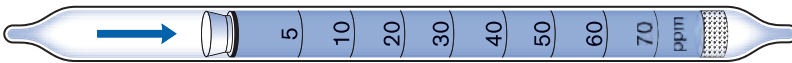

Dräger-Tube with a single indication layer

Examples include: Hydrazine 0,25/a
Ammonia 0,25/a

Short-term tubes with one or more pre-layers

In addition to the indication layer they have one or more pre-layers. These pre-layers are designed to:

- adsorb moisture or**
- trap interfering substances or**
- convert substances into measurable substances**

Examples include: Alcohol 100/a,
Hydrochloric Acid 1/a

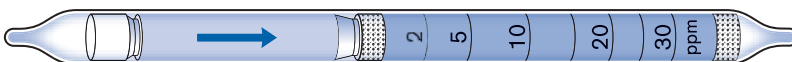

Dräger-Tube with one prelayer

Combination of two Dräger-Tubes

Two Dräger-Tubes, a pretube and an indication tube, are connected with shrink wrap tubing. Prior to the measurement, both inner tips and outer tips must be opened to allow air to be drawn through both tubes. The preparation in the pre-tube serves a purpose similar to the pre-layer of a single tube.

Examples include: Halogenated Hydrocarbons 100/a,
Formaldehyde 0.2/a

Short-term tubes with connecting tubes



ST-1225-2008

Combination of two Dräger-Tubes

These tubes consist of one indication tube and an additional tube. After breaking off the tube tips both tubes are connected with a short piece of rubber tubing supplied with the tubes. The additional tube must be connected in front of or behind the indication tube according to the instructions for use. If connected behind the indication tube, it functions as an adsorption layer for reaction products which result from the reaction in the indication tube. If it is connected in front of the indication tube, it functions similarly to the pre-layer in a standard Dräger-Tube.

Examples include: Tetrahydrothiophene 1/b



ST-1225-2008

Dräger-Tube with pre-tube

Short-term tubes with a built-in ampoule

Due to chemical incompatibility some reagents must be kept separate until just before the actual measurement. These tubes feature a built-in reagent ampoule in addition to the indication layer. The compound in the ampoule can be vaporous, liquid, or solid (i. e. granular).

Examples include:

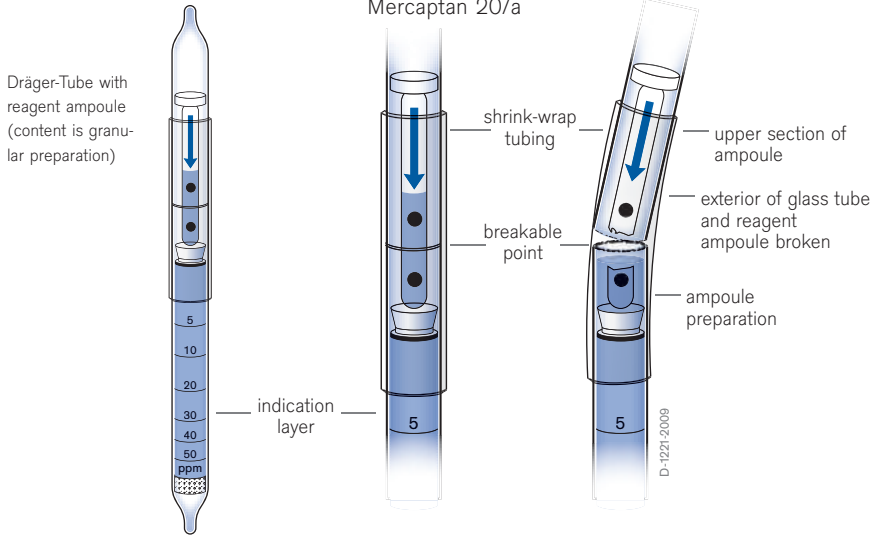

Dräger-Tube with built-in reagent ampoule

Dräger-Tubes for simultaneous measurement

A set of five specially calibrated tubes are provided in a rubber fixture. Each tube has one or two calibration marks for semiquantitative evaluation. The tips of all five tubes are broken and the set is connected to a five tube adapter which is connected to the Dräger-Tube pump (e. g. accuro) and the air sample is drawn through all five tubes simultaneously. Since the test sets are designed as a system, the use of other tubes is not recommended and will lead to erroneous results.



Test Set I for simultaneous measurement of inorganic combustion gases.

Examples include: Dräger Simultaneous Test Set I and II measurement of inorganic combustion gases. Dräger Simultaneous Test Set III measurement of organic vapors.

2.5 Evaluation of Dräger-Tubes

The evaluation of the indication on the Dräger-Tube is another important factor to be taken into consideration. The following are guidelines for interpreting the indication:

- continuously observe the tube during the measurement
- evaluate the indication immediately following the measurement according to the instructions for use
- use sufficient lighting
- light background
- compare with an unused tube

Observing the tube during the measurement is particularly important to make sure that a complete discoloration of the tube has not happened without being realised. This complete discoloration can sometimes occur abruptly with high concentrations even during the course of the first stroke.

A sufficient lighting source is necessary. However, direct sunlight should be avoided because the UV-radiation of the sun may cause a change in the discoloration. Since such a change can sometimes occur even after a longer period of time.

The reading of the tube must be done immediately following the measurement.

Also, keeping the used tube as proof is not useful in most cases, because even tubes which have been sealed with rubber caps will show a change in the indication over time.

A light background (white paper) is very helpful, in improving the readability of the discoloration. When there is no source of ambient lighting the reflector of a switched-on flashlight will suffice.

The comparison of a used tube with an unused one is yet another way to more accurately evaluate the discoloration.

In all cases the entire length of the discoloration must be read. This means the sum of all colors (e. g. carbon monoxide tubes produce light brownish green discolorations).

It must also be pointed out that an individual's perception of a particular color or intensity of a color is somewhat subjective. It is possible, for example, that one person calls a color light brown whereas another person calls the same color brown. These deviations in the individual perception of color or sense of color should not be overemphasised unless color blindness is an issue.

When reading the concentration on a scaled tube, three different situations can be encountered:

- the color indication ends at a right angle to the tube's longitudinal axis
- the color indication is oblique to the tube's longitudinal axis
- the end of the color indication becomes very diffuse

When the color indication is at a right angle to the tube's longitudinal axis, the concentration can be read directly against the scale (see example 1). If the color indication is oblique (i. e. runs in a slanting direction to the tube's longitudinal axis), then a long and a short discoloration can be observed. In this case the average reading indicates the concentration (see example 2). If the color indication become progressively diffuse, the end of the discoloration may be difficult to evaluate. In this case the final edge of the discoloration has to be read at the point where a faint discoloration is just visible (see example 3)

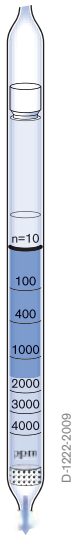

Example 1

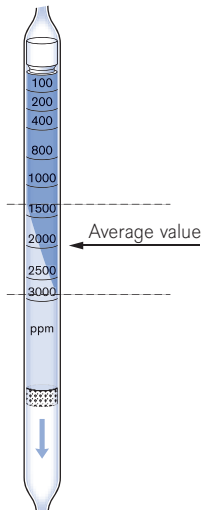

Example 2

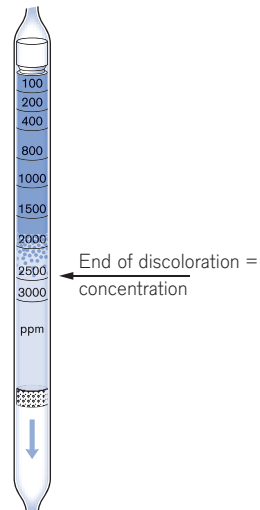

Example 3

2.6 Hot Air Probe

The hot air probe was developed for the measurement of hot gases. This probe is required when the temperature limit (usually up to 40 °C / 104 °F) given in the operating instruction sheet is exceeded.

At a higher temperature the volume of air drawn with the Dräger-Tube pump changes. Normally, the volume is 100 mL per pump stroke at 20 °C. The temperature dependence of the volume can be explained with Gay-Lussac's law.

$$V_t = \frac{V_0}{T_0} T$$

The hot air probe is designed to cool down hot gases so they can be measured directly with the Dräger-Tube system. If it is ensured that the probe does not remain in the gas flow for more than half a minute, even gases at a temperature of e. g. 400 °C are cooled to below 50 °C. The dead air space of the probe is so small that it can be ignored while measuring.

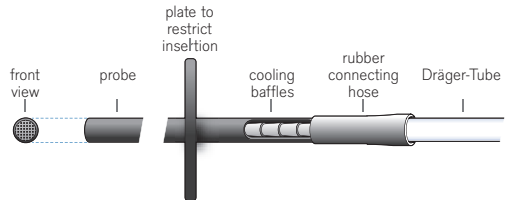
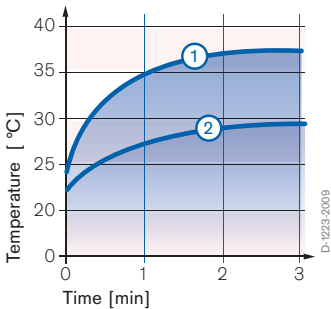

Cooling effect of the hot air probe
 gas temperature: 650 °C
 ambient temperature: 20 °C
 In 3 minutes 1 L of gas was drawn
 and the temperature in the tube rose
 according to the above curves
 (1) with one hot air probe
 (2) with two hot air probes

Sketch of the hot air probe

2.7 Extension Hose

An extension hose provides a convenient means to test the air quality in difficult to reach areas such as grain silos, storm drains, sewers and tanks, prior to entry. One end of the hose is equipped with an adapter to connect the extension tube securely to the Dräger-Tube pump. The other end of the hose has a tube holder assembly which provides a gas tight fit when the Dräger-Tube is inserted. The extension hose is made of a fuel resistant synthetic rubber.

Since the Dräger-Tube is connected at the inlet of the extension hose and the Dräger-Tube pump is connected at the outlet end of the extension hose, the volume of the hose has no influence on the reading. However, when extension hoses longer than the standard 3 m hose are used, correction factors or additional time to draw the sample may be required and should be reviewed with the local Dräger subsidiary or distributor.

2.8 Investigation of compressed Air, Medical Gases and Carbon Dioxide

In accordance with DIN EN 12021, compressed air used as breathable air must meet certain quality requirements. For example, air in an unloaded state cannot contain more than 5 ppm of carbon monoxide or 500 ppm of carbon dioxide. The water content in unloaded air, in the case of a drop in pressure of 40 to 200 bar, must be below 50 mg/m^3 . In the case of a fall in pressure of $>300 \text{ bar}$ it must be below 35 mg/m^3 . In case of a drop in pressure of 5 to 40 bar the permitted water content is listed in a table of the standard DIN EN 12021. Furthermore, unloaded air must also be free from odor or taste (this is generally guaranteed if the oil content is below 0.1 mg/m^3). In addition, the water content of unloaded air released by the compressor must not exceed the total pressure range of 25 mg/m^3 (DIN EN 12021).

In order to check these parameters, as well as to satisfy the intended application of the various media in the form of application-specific and country-specific regulations, a quantitative test of the medium can be performed using the Aerotest line of products. Dräger has been active for over 100 years in the field of compressed air analysis. The Aerotest line of products allows simultaneous measurement of pollutants in outgoing air, as well as in oxygen, nitrous oxide and carbon dioxide. Dräger-Tubes form the basis for these measurements. The Simultan Aerotest and tubes make it possible to take a measurement in just 5 minutes. The volume flow required for the pollutant measurement (flow through Dräger-Tubes) is realized using a precise pressure relief valve and special dosage devices. Regardless of the compressor's primary pressure (max. 300 bar), the loop, or the respective residual filling pressure in the buffer cylinders, a consistent volume flow can be supported. The Aerotest Simultan is a compact design and can be connected to standard compressors, buffer cylinders, or loops without the use of additional tools.



Dräger Aerotest Simultan

In 2008, measurement using impactor technology was introduced, in order to detect oil mist in compressed air. In general, impactors collect aerosol particles, making this technology excellently suited to detecting oil mists.

The impactor is used together with an adapter in the Dräger Aerotest Simultan.

During the measurement, the air to be inspected flows through 20 nozzles in the impactor, before hitting a baffle-plate, made of cut glass, at right angles. The 90 ° redirection of air in the impactor separates the aerosol particles in the air flow on the glass plate due to their high inertia. The recesses in the glass grinding are then filled with the oil. This nullifies the light diffusion caused by the glass grinding. This principle allows for the visual recognition of small quantities of oil.



Impactor with Adapter in Aerotest Simultan

ST-602-2008

Due to the special arrangement of the nozzles, the quantity of separated oil, and therefore the oil aerosol concentration if the air quantity is known, can be measured with good reproducibility.

The measurement result is independent on the oil grade. However, note that oil aerosols vaporize at high temperatures, and the vapor is not shown. The measurement lasts 5 minutes with a volume flow of 4 L/min, making a test volume of 20 L.

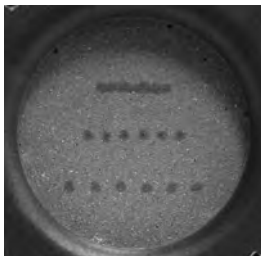

0.1 mg/m³

ST-1230-2008

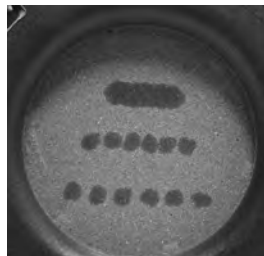

0.5 mg/m³

ST-1231-2008



1 mg/m³

ST-1232-2008

Impactors with 3 different oil aerosol concentrations.

Dräger Aerotest 5000

64 01 220

The Dräger Aerotest 5000 is used to measure the quality of breathing air delivered by a low-pressure system 2,5 to 10 bar (e.g. compressor or compressed air cylinder). The quality of the breathing air can be tested in accordance to DIN EN 12021 by means of quantitative measurements of the contaminations. Dräger-Tubes or Dräger Impactor are used for measuring. The values can be measured both simultaneously or individually. Data can be stored. All components of the Aerotest 5000 are arranged in a carrying case ready for use. Optional measurements by high pressure systems with pressure regulator F3002 can be used.



D-11163-2011

Dräger Aerotest 5000

Dräger Aerotest Simultan HP, complete 65 25 951

For checking breathable air in high-pressure areas. The monitoring of the breathing air quality according to the requirements of EN 12021 is performed by means of a quantitative measurement (of the contaminations) in the compressed air flow within 5 minutes. The measuring device (G 5/8" connection DIN 477) can be connected to the high-pressure compressed air supply system to be monitored. All components of the Aerotest Simultan HP are arranged in a carrying case and ready for use.



ST-7001-2008

Dräger Aerotest Simultan HP, complete

Dräger Aerotest Alpha, complete 65 27 150

For checking breathable air in low-pressure areas of 3 to 15bar. The monitoring of the breathing air quality, according to the requirements of DIN EN 12021, is performed by means of quantitative measurement (of the contaminations) in the compressed air flow. The measuring device (barbed fitting connection) can be connected to the low-pressure compressed air supply system to be monitored. All components of the Aerotest Alpha are arranged in a carrying case and ready for use.



D-6654-2009

Dräger Aerotest Alpha, complete

Dräger MultiTest med. Int., complete 65 20 260

For checking medical gases in supply systems. The Multitest med. Int. and Dräger tubes can be used to detect contamination in compressed air, laughing gas, carbon dioxide and oxygen, in accordance with USP (United States Pharmacopeia) requirements. Dräger tubes are used for the quantitative detection of water vapor, oil, CO₂, SO₂, H₂S, NO_x, CO and other contaminations in medical gases. The measuring device is connected with the various barbed fitting adapters. All components of the MultiTest med. Int. measuring device are stored in a handy carrying case.



D-8655-2009

Dräger MultiTest med. Int., complete

Dräger Simultan Test CO₂, complete 65 26 170

For checking carbonates (CO₂) in low-pressure areas of 3 bar. The monitoring of carbonates is performed by means of quantitative measurement (of contaminations) in the carbon dioxide flow. The measuring device (barbed fitting connection) can be connected to the carbon dioxide tube system to be monitored. Dräger tubes are used for the quantitative detection of water vapor, NH₃, NO_x, CO, SO₂, H₂S and other contaminations in carbon dioxide. All components of the Simultan Test CO₂ measuring device are stored in a handy carrying case.



D-16885-2017

Dräger Simultan Test CO₂, complete

Dräger Aerotest Navy, complete 65 25 960

The device determines the quantity of hydro steam, oil, CO₂, CO and other contaminations in the air flow supplied by high-pressure compressors or compressed air at a max. pressure of 300 bar. The pressure is limited by a pressure reducer. The air to be monitored is tested by means of a flowmeter. The compressed air is supplied through a special direct scanning tube, which analyzes the quantity. The monitoring of the breathable air quality is performed in accordance with DIN EN 12021. All components of the Aerotest Navy are stored in a handy carrying case.



Dräger Aerotest Navy, complete

2.9 Proposed Strategy for Determining Gas Hazards

The measurement of air pollution presents a special challenge especially when encountered at hazardous waste sites, fires, or transportation accidents involving chemicals. In this case, a risk analysis is hindered by the possible existence of several contaminants in the air.

In addition to portable gas detection instruments, Dräger-Tubes and Dräger Chips can be used for on-site measurements and to assist in the identification of gaseous substances. Because of the diverse possibilities regarding the substances, it is not possible to only use a single Dräger-Tube or Chip to determine all the imaginable combinations of gas dangers. Taking into account certain considerations and experiences, a suggestion for a measurement strategy has been developed. With this strategy, the time to make a first classification of the most important substance groups can be considerably shortened.

Of course, every suggestion is more or less the best possible compromise, when the practicability is complicated by a growing uncertainty.

Multiple test sets

For these special applications, Dräger has developed multiple test sets for carrying out simultaneous measurements. Each set consists of five specially calibrated tubes assembled in a rubber fixture. At this time there are two sets available for the measurement of inorganic combustion gases (Dräger Simultaneous Test-Set I and II) and a third set, for the measurement of organic substance groups (Dräger Simultaneous Test-Set III).

The use of such multiple measurement devices has substantial advantages compared with individual Dräger-Tube measurements:

- significant reduction of the measuring time
- detection of five contaminants and the relative concentrations at once

The Dräger Simultaneous Test-Sets are delivered pre-assembled and are connected to the Dräger-Tube pump via an adapter after opening the tube tips.

The Dräger-Tubes that make up each set do not have complete calibration scales. Instead, they have one or two calibration marks. These marks are orientated on the limit values for workplaces. To achieve the same air flow through each tube, the individual flow resistances of the Dräger-Tubes are very carefully matched, therefore, no other detector tubes may be used as substitutes in the rubber fixture.

Using three concentration sections the evaluation of the Simultaneous Test-Sets can be basically classified:

- non critical concentration range
- critical concentration range
- highly critical concentration range

The concentration range is indicated by the length of the discoloration. The following drawings describe the evaluation of the single tubes in the Simultaneous Test-Sets. In the

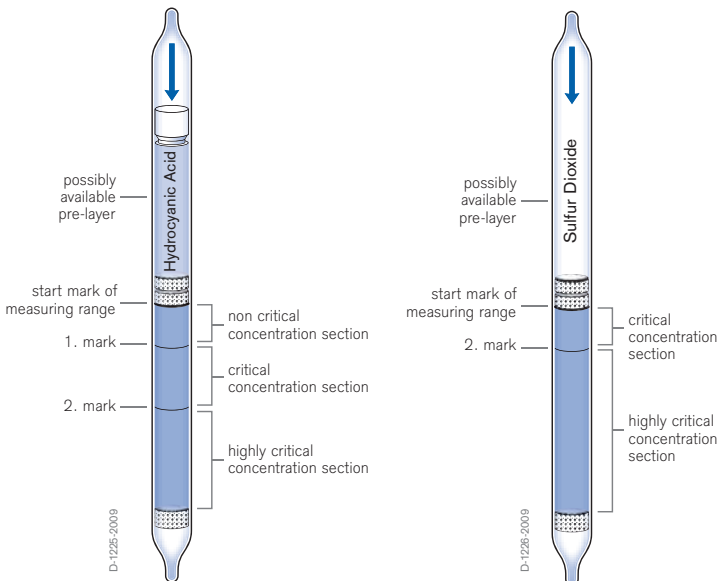

Simultaneous Test-Set II there is a special evaluation of the Dräger-Tubes for chlorine, phosgene and sulfur dioxide. On these tubes, the second mark is missing.

Whenever the concentration of a gas is critical or highly critical the actual concentration of this gas is verified using the respective Dräger-Tube.

A decision about possible measures always depends on how the concentration of the emerging gas will develop. In addition, the individual ambient conditions must be taken into account. Therefore, decisions can principally only be made by the incident commander on site.

Measurement of combustion and decomposition gases

In every fire, combustion and decomposition gases are evolved. There is danger of combustion and decomposition gases developing in higher concentrations during and particularly after the fire. These gases present a significant toxicity hazard for persons in the immediate as well as adjacent areas. These areas include e. g.

- adjoining rooms
- adjacent floors
- adjacent buildings
- neighboring streets

To realise the full benefit of these tests, both sets must be used, otherwise hazardous gases with poor warning properties could be overlooked.

Studies have shown that more than 450 substances are evolved as the result of fire. While all of these gases are not present in every fire, there are 11 inorganic gases that are most commonly present. Ten of these gases are measurable using the

- Dräger Simultaneous Test-Sets I and
- Dräger Simultaneous Test-Set II



Measuring with the
Dräger Simultaneous Test-Set

Although Dräger Simultaneous Test-Sets I and II were developed to provide measurements in the immediate area of a fire (either during the fire or during the clean-up), they are also very useful to assess the spread of the combustion and decomposition gases to other areas.

Measurement of organic vapors

Solvents and other organic vapors can be involved e. g. during hazardous accidents. For such cases the Simultaneous Test-Set III for organic vapors was developed. Ketones, aromatics, alcohols, aliphatics, and chlorinated hydrocarbons can be indicated with this set.

Measurement strategy

Dräger-Tubes are suitable for obtaining quick assistance when determining certain dangers due to gases on dumpsites for hazardous waste or after accidents, during fires etc. A statistical analysis of such events in which the individual toxic substances could be identified revealed that in 60 to 65 % of all cases combustible substances were present and there was therefore danger of explosion. For this reason principally the danger of explosion should be determined before using the Dräger-Tubes, preferably combined with measurement of the oxygen and carbon monoxide levels. The Dräger X-am product family (Dräger X-am 2500 to Dräger X-am 8000) for example, may be used, being equipment with catalytic or electrochemical sensors.

The Dräger Simultaneous Test Sets were developed so as to obtain information concerning health hazards by rapid measurements in the immediate vicinity.

Apart from registering individual substances, they are also designed to record groups of substances, since the reaction systems they use are deliberately chosen to be non-specific. In certain circumstances information about acidic substances may, for example, be sufficient to be obtain a more detailed characterisation.

In addition to the measurements using the Dräger Simultaneous Test Sets, which are meant to offer quick assistance in decision-making when determining dangers due to gas, the full range of classical Dräger-Tubes is available for measuring more precisely. When necessary, samples can be taken on site, to be analysed subsequently in the laboratory.

The combination of the Dräger X-am family and the Dräger Simultaneous Test Sets I, II and III complement one another. Together they constitute a recommended strategy. In practical situations, this suggested strategy forms the basis for the action to be taken in over 85% of cases. The results of the measurements hold only for the place and the time at which the measurement is taken (momentary concentrations). Specific circumstances that differ from case to case, may call for other special strategies.

ST11234-2008



The proposed strategy refers to the substances or groups of substances listed in the table. The proposed strategy may not be complete. For other substances or groups of substances which might be present, it may be necessary to carry out further measurements using other methods. The above mentioned measuring ranges are valid for 20°C and 1013 hPa.

Portable Instruments Dräger X-am 27000500	Proposed Strategy for the Determination of Gas Hazards (Warning against Explosion Hazards and Lack or Surplus of Oxygen)	Simultaneous Test-Set Conductive Compounds 1. Scale Mark 1. Carbon monoxide 33 ppm 2. Hydrocyanic acid 3.5 ppm 3. Hydrochloric acid 11 ppm 4. Nitrous gases 8.2 ppm 5. Formaldehyde 1 ppm	Further Measurements using CMS Analyzer und Chips Carbon monoxide 5 – 150 ppm Hydrocyanic acid 2 – 50 ppm Hydrochloric acid 1 – 25 ppm Nitrogen dioxide 0.5 – 25 ppm Formaldehyde 0.2 – 5 ppm	Further Measurements using Dräger X-act 5000 or accuro and Dräger-Tubes Carbon monoxide 10/b 10 – 3000 ppm Hydrocyanic acid 0.5/a 0.5 – 50 ppm Hydrochloric / Nitric acid 1/a 1 – 15 ppm Nitrous Fumes 0.2/a 0.2/a – 6 ppm Formaldehyde 0.2/a 0.2 – 5 ppm
Simultaneous Test-Set I for Inorganic Fumes 1. Scale Mark 2. Scale Mark 1. Acid gas 5 ppm 25 ppm 2. Hydrocyanic acid 10 ppm 50 ppm 3. Carbon monoxide 30 ppm 150 ppm 4. Basic gas 50 ppm 250 ppm 5. Nitrous gas 5 ppm 25 ppm		Hydrochloric Acid 1 – 25 ppm Hydrocyanic acid 2 – 50 ppm Carbon monoxide 5 – 150 ppm Ammonia 10 – 150 ppm Nitrogen dioxide 0.5 – 25 ppm	Hydrochloric / Nitric acid 1/a 1 – 15 ppm Hydrocyanic acid 0.5/a 0.5 – 50 ppm Carbon monoxide 10/b 10 – 3000 ppm Ammonia 5/a 5 – 600 ppm Nitrous Fumes 0.2/a 0.2/a – 6 ppm	
Simultaneous Test-Set II for Inorganic Fumes 1. Scale Mark 2. Scale Mark 1. Sulfur dioxide – 10 ppm 2. Chlorine – 2.5 ppm 3. Hydrogen sulfide 10 ppm 50 ppm 4. Phosphine – 0.3 ppm 5. Phosgene – 0.5 ppm	Sulfur dioxide 0.4 – 10 ppm Chlorine 0.2 – 10 ppm Hydrogen sulfide 2 – 50 ppm Phosphine 0.1 – 2.5 ppm Phosgene 0.05 – 2 ppm	Sulfur dioxide 0.5/a 0.5 – 25 ppm Chlorine 0.2/a 0.2 – 30 ppm Hydrogen sulfide 1/c 1 – 200 ppm Phosphine 0.01/a 0.01 – 1 ppm Phosgene 0.02/a 0.02 – 1 ppm		
Simultaneous Test-Set III for organic Vapors 1. Scale Mark 2. Scale Mark 1. Ketones 1000 ppm 5000 ppm 2. Aromatics 100 ppm 500 ppm 3. Alcohols 200 ppm 1000 ppm 4. Aliphatics 50 ppm 100 ppm 5. Chlorinated hydrocarbons 50 ppm 100 ppm	Acetone 40 – 600 ppm Benzene 0.2 – 10 ppm Ethanol (Alcohol) 100 – 2500 ppm Petroleum Hydrocarbons 20 – 500 ppm Perchloroethylene 5 – 500 ppm	Acetone 100/b 100 – 12000 ppm Toluene 50/a 50 – 400 ppm Ethanol 100 – 3000 ppm Hexane 10/a 10 – 2500 ppm Perchloroethylene 10/b 1 – 500 ppm		

Portable Instruments
 Dräger X-am 2500 / 8000
 (Warning against Explosion
 Hazards and Lack or Surplus
 of Oxygen)

Proposed Strategy for the Investigation of Substances using Dräger-Tubes®

Detection of different Organic and some Inorganic Substances

Polytest

Acetone Acetylene Arsine	Gasoline (Fuel, (Petroleum) Benzene Ethylene	Liquefied Petroleum Gases (Propane, Butane) Carbon Monoxide, Mono Styrene	Perchloroethylene Carbon Disulphide Hydrogen Sulfide	Natural Gas (with more than 2 Vol.-% CO) Nitrogen Monoxide (NO) Toluene, Xylene, Trichloroethylene
--------------------------------	---	--	--	--

positive

Detection of different Organic Substances

Ethyl Acetate 200/a

Ester from Acetic Acid, Alcohols, Ketones, Benzene,
 Toluene, Petroleum Hydrocarbons

positive

Detection of some Halogenated Hydrocarbons

Perchloroethylene 2/a

Perchloroethylene, Chloro-
 form, Dichloroethylene,
 Dichloroethane, Dichloro-
 propene, Trichloroethylene
 Methyl Bromide

negative

Detection of Amine

Amine Test

Triethylamine UN-Nr.: 1296,
 Ethylenediamine, Hydrazine,
 Ammonia

positive

Detection of impor- tant Aromatic Hydrocarbons:

Toluene 5/b

Benzene UN-Nr.: 1114,
 (Ethyl Benzene, Toluene and
 Xylene discolored the pre-
 layer in lower concentration)

Detection of Ketones:

Acetone 100/b

Acetone UN-Nr.: 1090
 Methyl Isobutyl Ketone,
 2-Butanone

Detection of Alcohols:

Alcohol 100/a

Alcohol UN-Nr.: 1096
 Butanol, Methanol, Propanol

negative

Detection of Propane Butane:

Hydrocarbon
 0,1 %/c

Propane UN-Nr. 1978

Detection of CO:

Carbon Monoxide 10/b

CO UN-Nr. 1016

Further Detection

of other substances if
 necessary

positive

Detection of Phosgene:

Phosgene 0,25/c

Phosgene

Detection of Acid Reacting Substances:

Acid Test

Hydrochloric Acid
 UN-Nr. 1789,
 HNO₃, Cl₂, NO₂, SO₂

Further Detection

of Methane, Ethane, H₂,
 CO₂ and of other
 substances if necessary

ST-1234-2008



This proposed measurement strategy refers to the substances or groups of substances listed in the strategy. The strategy may not be complete. For other substances or groups of substances which may be present, it may be necessary to carry out further measurements using other methods. The Dräger-Tubes shall only be used with a Dräger-Tube Pump.

2.10 Measurement of Fumigants

In order to prevent damage through animals such as insects and other disease carriers, or to disinfect and sterilize spaces, enclosed spaces are flooded with poisonous or asphyxiant gases.

In present times, with increased demand and a global transport system, many different applications exist for fumigants:

- fumigation of storage areas for foodstuffs,
- fumigation of granaries and grain cargo ships,
- fumigation of containers with all types of goods, during transport,
- fumigation in medical field, for sterilization and disinfection,
- fumigation of buildings or parts of buildings (e.g. houses, apartments, churches, museums, etc.).

Different fumigants or other substances are used, depending on the application area. For example, ethylene oxide and formaldehyde are used for sterilization and disinfection in medical areas. In addition, ammonia is used as an additive for neutralization.

In order to protect agricultural products like grain, vegetables, fruit, nuts, tobacco, etc., phosphine is used to poison insects. Inert gases, such as nitrogen, carbon dioxide and noble gases (primarily argon) are used to displace oxygen and suffocate insects.

Methyl bromide, sulfuryl fluoride and hydrocyanic acid are used to fumigate furniture, wooden products, electrical devices, etc. during transport, and to fumigate buildings and rooms.

It has also been possible to determine such adventurous procedures as the impregnation of leather goods with benzene. Benzene was used by senders when transporting goods in containers, in order to avoid the possible build up of mold on the leather due to air humidity and high temperatures.

Fumigants are used in tablet form. They are then placed in the rooms or containers. They are distributed equally around the entire room in order to achieve the desired level of efficiency. Sometimes, however, they are just placed in one position, such as directly behind the door of a container or on the opposite side of the container to the door. This is particularly dangerous, as it can result in a sudden cloud of fumigant when the container door is opened or when unloading goods.

The concentration of the fumigants used must be measured in order to protect persons present at the start and finish of the fumigation procedure when loading and unloading fumigated products from transport containers, or in case of possible leakages.

This is simple if the fumigants used are known. The range of Dräger-Tubes means that the appropriate tubes or Dräger-Chips can be used, according to the substance and measurement area. However, whenever the fumigant is not known, it is also not clear which Dräger-Tube should be used for the measurement. This question often arises in the field of container transport, where it can be triggered by a missing label of the fumigant used, or a complete lack of reference to fumigation.

Fumigants are highly toxic and can be harmful to health in many other ways. For this reason, suitable measuring instruments should generally be used to check which fumigant has been used (if any) before opening a container. Do not forget to measure the oxygen concentration. Gases used displace the air, including atmospheric oxygen, resulting in a perilous risk of suffocation due to lack of oxygen. This kind of lack of oxygen can be caused relatively easily by leakages in individual packages in the container.

Here is a short overview of regularly used substances, to give you an impression of how dangerous fumigants can be:

- **Carbon dioxide**

Colorless, odor-free, non-combustible gas. It is heavier than air, meaning it can displace atmospheric oxygen in poorly ventilated spaces and form CO₂ reservoirs: risk of suffocation.

- **Phosphine**

Colorless, odor-free gas, highly poisonous, highly flammable.

- **Methyl bromide**

Colorless gas, smells slightly of chloroform, poisonous, carcinogenic.

- **Sulfuryl fluoride**

Colorless, odor-free gas, virtually inert, heavier than air, poisonous, non-combustible.

- **Hydrocyanic acid**

Colorless liquid with typical smell of bitter almond, boiling point 26 °C, highly poisonous, highly explosive when mixed with air.

- **Ethylene oxide**

Colorless, sweet smelling gas, heavier than air, poisonous, carcinogenic, highly flammable.

- **Formaldehyde**

Colorless, pungent smelling gas, poisonous.

- **Ammonia**

Pungent smelling, colorless gas, corrodes and chokes, poisonous, forms explosive mixture with air.

Performing measurements

If the fumigant is known, the corresponding Dräger-Tube is selected and the measurement is executed. Depending on the concentration determined, the room can then be entered or the container opened. If the measured concentration is too high, it is ventilated and a new measurement is taken in order to be able to release the room or container. The measurement of fumigants in containers should only take place when the container is still closed. To do this, the Dräger probe (Order No.: 83 17 188) is inserted through the rubber seal of the container door. In doing this, the Dräger probe causes the rubber seal of the container door to bulge at its lowest point, and the probe is pushed as far as possible into the container. The Dräger-Tubes are prepared for the measurement, and are connected to the probe. The pump strokes required for the measurement are then executed using the Dräger-Tube pump.



ST-4324-2003

Measurement in front of the container door

If the fumigant used is not known, we recommend using the Simultaneous Test-Sets for fumigation to determine which fumigant was used. The Simultaneous Test-Sets allow you to measure five fumigants at the same time:

- Ammonia
- Methyl bromide
- Hydrocyanic acid
- Phosphine
- Formaldehyde
- or ethylene oxide instead of ammonia



ST-4324-2003

Measurement using the probe

If the Simultaneous Test-Set displays one or more gases, the container is ventilated with air before being entered, and the concentrations of the corresponding gases are then tested again with individual tubes.

In addition, the following Dräger-Tubes are used for measuring sulfuryl fluoride, ethylene oxide and carbon dioxide:

Sulfuryl fluoride	1/a	measurement range	1 to 5 ppm
Ethylene oxide	1/a	measurement range	1 to 15 ppm
Carbon dioxide	0.1%/a	measurement range	0.1 to 6 Vol. -%

We recommend using the Dräger Pac 6500 with an electro-chemical sensor for measuring oxygen (measuring range 0 – 25 Vol.-%). It is particularly small and handy.

If the concentration of carbon dioxide is to be measured at the same time, the Dräger X-am 8000 can be used, as this has an IR-CO₂ sensor (measurement range 0 – 5 or 0 – 100 Vol.-%). This is the best sensor for this type of CO₂ measurement. In this measuring device an electro-chemical sensor (measuring range 0 – 25 Vol.-%) is used to measure oxygen.

Whenever a measurement is to be taken to determine risk of explosion, note that catalytic ex-sensors in an inert atmosphere (e. g. caused by the leakage of inert gases) do not work. You need atmospheric oxygen for the measurement. In this case, the Dräger X-am 8000 should be used with an infrared ex-sensor.

2.11 Determination of Volatile Contaminants in Liquid Samples

The Dräger Liquid Extraction method (DLE) is used for the determination of volatile contaminants in water. The measurement basically consists of two steps:

- the extraction of the contaminant
- the measurement of the contaminant

During the extraction process, the contaminant in the water sample is transferred from the liquid phase into the gas phase. A 200 ml sample of water is poured into a specially calibrated gas washing bottle. The Dräger-Tube is attached to the outlet of the bottle and a specific volume of air is drawn through the water sample. The porous frit in the bottle produces a high number of small air bubbles in the water which extract the contaminant as they break at the surface. The extracted contaminant is measured from the headspace of the bottle in the Dräger-Tube. To avoid the interference of the result by contaminants of the air a carbon pre-tube must be installed in front of the gas washing bottle.

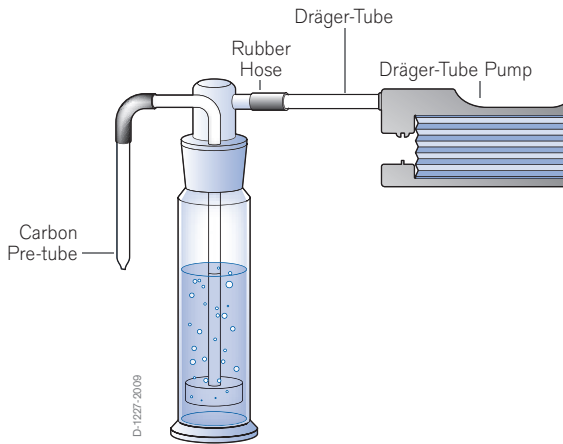

Measurement system of the Dräger Liquid Extraction method

Since the measurement process is a function of a number of substance and device specific parameters, the measurement result has to be calculated by including various constants. The calibration constant A is a rate for the extraction efficiency of the gas washing bottle and is given on the bottle and the bottle insert. The system constants B and C are a function of the sample temperature, the extraction volume, and the substance specific parameters. The B and C constants are given in the special DLE instructions published by Dräger. The calculation of the contaminant concentration Y is done with a linear equation, in which the colorimetric indication X read off the Dräger-Tube is usually given in ppm. The contaminant concentration e. g. in a water sample can be calculated by:

$$Y_{[\text{mg/L}]} = A \cdot B \cdot (x_{[\text{ppm}]} + C)$$

2.12 Detection of Air Flows

In some areas the detection of air currents is of particular importance. Slight air currents must become visible to estimate their source, direction and speed. This is necessary e. g.:

- **in mining**
for the monitoring of firedamp in inaccessible places;
- **in the industry**
for detection of leaks in pipelines, of air currents in rooms or for combustion plants and in laboratory stacks;
- **in the ventilation technique**
for control and setting up of air conditioning plants



Dräger air flow tester

In addition to this measurement of the air currents are also helpful when estimating e. g. the distribution of toxic substances at workplaces. The knowledge of the air flow pattern permits objective selection of the right measuring points for any air analysis.

With this aim in view Dräger developed an air flow tester. This Dräger-Tube consists of a porous carrier impregnated with fuming sulfuric acid. After opening the tube tips the air is pumped through the tube with the help of a rubber bulb. The white smoke emerging from the tube is carried along by the air flow and makes its direction visible. The air flow tester can be used repeatedly until the smoke is finally exhausted. If the test is completed before the tube is exhausted, the tube should be sealed with the rubber caps provided.

Dräger Flow Check

The Dräger Flow Check air current indicator produces a harmless cloud of smoke that floats freely and easily, because it has the same density as ambient air. Consequently, slight air currents become visible.

The Dräger Flow Check consists of:

- **an instrument for the production of the clouds**
- **an ampoule containing smoke-generating fluid**

The ampoule contains a fluid that is a special mixture of alcohols developed at Dräger. A small heating element in the head of the instrument heats the fluid which condenses on contact with the ambient air. The temperature of the heating element and the quantity of the fluid is electrically balanced.

The Dräger Flow Check incorporates ergonomic form, low weight, and optimal operation into the instrument design. The instrument will generate clouds in any orientation.



ST-61-98

Small, single clouds can be generated with a short press of a button. If a continuous production of clouds is desired, the button can be held or locked in the "on" position. The fluid ampoule is located in a compartment in the handle of the instrument and can be inserted effortlessly into position. The amount of fluid contained in the ampoule is enough to generate approximately five minutes.

Power is supplied by a battery located in the handle of the instrument and can be charged while inside the instrument or separately. A quickcharge option is also possible with the charger. An adapter cable can be used to charge the device from a car mounted cigarette lighter.



ST-64-98

Dräger Flow Check

2.13 Dräger-Measurement-Systems for Long-term Measurements

The Dräger diffusion tubes are direct reading systems used for the determination of time weighted average concentrations over the duration of one to eight hours. Since these are passive measurement systems, relying on the diffusion of contaminant molecules in air, they do not require a pump. The diffusion tubes are used with a plastic holder which is attached to the clothing (shirt collar, pocket, etc.).

The scale printed on the diffusion tube represents the product of the concentration and exposure time given e. g. as ppm x h, ppm x min, Vol.-% x h or mg/L x h. To determine the average concentration of the contaminant, the scale reading is divided by the exposure time (i. e. sampling time) according to the following:



ST-1850-2004

Dräger-Diffusion-Tubes with direct indication

$$c = \frac{\text{indication in ppm} \cdot \text{h}}{\text{time in h}} \quad [\text{ppm}]$$

2.14 Expiration Date, Storage, and Disposal of Dräger-Tubes

Each Dräger-Tube contains a reagent system designed to undergo a chemical reaction with a particular substance. Since chemicals and chemical reagents are not stable indefinitely, each box of Dräger-Tubes is stamped with an expiration date. The tubes are suitable for use through the last day of the month of expiration. Tubes used beyond the expiration date cannot be relied upon to give accurate results.

For the accuracy of the tube indication, throughout the shelf life, Dräger-Tubes should be stored in the original package at room temperature. A note on the package indicates a maximum storage temperature of 25 °C (i. e. 77 °F). Avoid excessively low (less than 35 °F) or high (greater than 77 °F) temperatures during storage and do not subject the tubes to light for prolonged periods.

Do not dispose of used or expired Dräger-Tubes in domestic waste. Dräger-Tubes must be disposed of properly, since the reagent system of the tube contains chemicals, even though the chemicals are present in extremely small amounts. The storage or disposal of chemicals must be conducted according to local, state and federal regulations. Detector tubes are comprised primarily of glass and chemicals. Keep detector Tubes and all chemicals out of the reach of Children.

2.15 Dräger-Sampling-Systems

Monitoring hazardous substances in the air by means of measurements often requires a considerable expenditure with regard to the instrumentation and personnel. This is particularly true when the measurements are done on site and there is no direct reading Dräger-Tube available for the particular application. Under these conditions, a sample must be taken using a suitable collection device and sent to a laboratory for analysis.

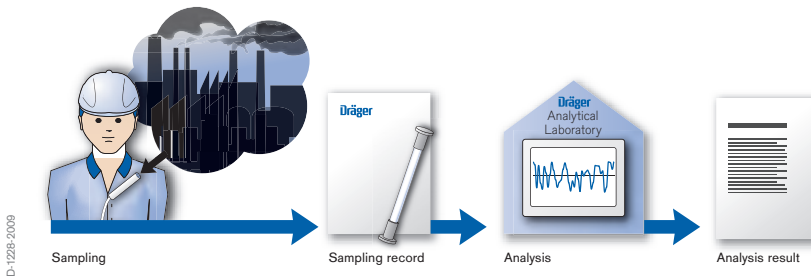

Air investigations at the workplace by sampling on site followed by laboratory analysis.

Using the Dräger sampling system, hazardous substances in the air are collected using a suitable medium via adsorption or chemisorption. The sample is then analysed in the laboratory by means of various analytical methods like gas chromatography (GC), high performance liquid chromatography (HPLC), UV-VIS photometry, or IR spectroscopy.

In the case of a stationary measurement the sampling system is placed at the chosen measurement site for the duration of sampling. When performing personal air monitoring the sampling system is attached to the clothing of the person as close as possible to the inhalation area.

Active Sampling

For active sampling the air to be evaluated is drawn through a sampling tube with a pump. The substance to be collected accumulates on the adsorbent.

Taking the contaminant mass (m_i), determined by the laboratory analysis and the air volume (V) drawn through the sampling tube, the concentration (c_i), of the contaminant can easily be calculated:

$$c_i = \frac{m_i}{V} \text{ [mg/m}^3\text{]}$$

The sampling tube features a primary adsorption layer and a secondary layer which are analysed separately in the laboratory. This separate analysis determines whether the entire amount of the measured substance was adsorbed. During sampling the measured substance is first adsorbed at the primary adsorption layer. Sometimes the capacity of this layer is not sufficient, and there is break through resulting in additional adsorption at the secondary layer. When this occurs a new sample must be taken because it is not possible to be sure that the entire amount was adsorbed by the two layers (i.e. the secondary layer could also have experienced break through).

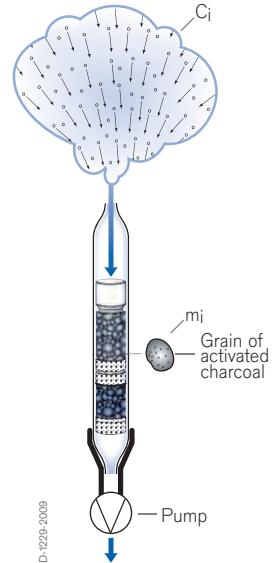

Measurement principle of active sampling with Dräger activated charcoal tubes

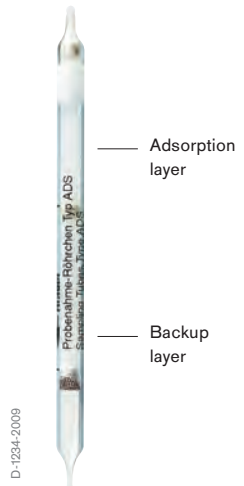

Dräger sampling tube

The air volume to be drawn through the sampling tube is a function of the measured substance and the expected concentration. Usually the volume is between 1 and 20 L.

Since the air volume is used as a reference for the concentration calculation (following the laboratory analysis), the pump has to meet strict criteria. Within the context of the Dräger sampling system the Dräger-Tube pump accuro, or the Dräger X-act 5000 are suitable for short-term measurements.

Sampling tubes for active sampling

Dräger-Tubes	Primary adsorption layer	Backup adsorption layer
Activated Charcoal Type NIOSH coconut shell charcoal	100 mg	50 mg
Activated Charcoal Type B coconut shell charcoal	300 mg	700 mg
Activated Charcoal Type G coconut shell charcoal	750 mg	250 mg
Silica Gel Tube Type NIOSH	140 mg	70 mg
Silica Gel Tube Type B	480 mg	1,100 mg
Silica Gel Tube Type G	1,100 mg	450 mg
Sampling Tube Amines for aliphatic amines and dialkyl sulfates	300 mg	300 mg

Passive Sampling

Passive sampling is performed with diffusion samplers like the Dräger ORSA or the Dräger Nitrous Oxide diffusion samplers. In contrast to active sampling the transport of the contaminant molecules is achieved by diffusion processes and not by using a pump. Contaminant molecules from the ambient air follow a defined diffusion course and are adsorbed by the sorption agent of the diffusion sampler.

Fick's law of diffusion is used for the calculation of the adsorbed substance mass:

$$\Delta c_i = \frac{m_i \cdot L}{D_i \cdot t \cdot A} \text{ [mg/m}^3\text{]}$$

In this context m_i is the substance mass which in the time t diffuses through the sectional area A of the sampler vertically to the concentration grade and Δc_i is the concentration difference along the diffusion course L . Δc_i is basically equivalent to the ambient concentration. The diffusion coefficient D_i is substance specific.

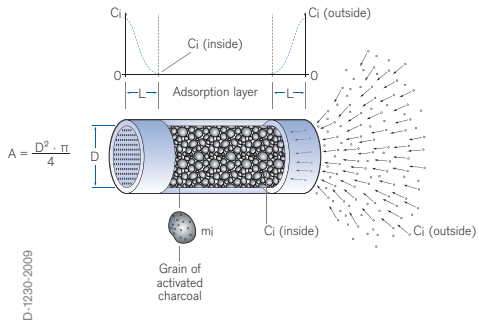

Measurement principle of the Dräger Diffusion sampler ORSA

The diffusion samplers are generally designed to sample over a long period of time for the determination of average concentrations. They are usually used for 1 to 8 hours. In addition the diffusion sampler Dräger ORSA can be used for the investigation of lower concentration ranges over a period of time of up to 168 hours (e.g. for the sampling of perchloroethylene in living spaces).

Sampling tubes for passive monitoring

Diffusion sampler Adsorption layer

Dräger ORSA 400 mg Activated Charcoal from coconut shell charcoal

Nitrous Oxide 400 mg Molecular Sieve

2.16 Measurement of Aldehydes and Isocyanates at the Workplace

Aldehydes are industrially produced in large volumes. They are applied in products of synthetic resin, rubber and adhesives. The different compounds of aldehydes are also found in disinfectants, colors, lacquers and plastics. The most important substances are formaldehyde, glyoxal, glutardialdehyde, acetaldehyde and acrolein.

Isocyanates are of particular interest for industrial applications because they readily react with polyalcohols to form polyurethanes. Polyurethanes are some of the most versatile thermoplastic polymers available. They are recognized for use as coatings because of their hardness, gloss, flexibility and abrasion resistance. As an elastomer they offer good resistance to abrasion, weathering and attack by organic solvents. As a foam they are excellent insulators.

Trying to monitor the occupational exposure limits for isocyanates is very demanding on a measurement method:

- low exposure limit,
- low cross sensitivity for other substances apart from isocyanates,
- sampling should be possible in the inhalation area of an employee,
- less qualified personnel should also be able to perform the sampling.

These requirements are met by two measurement methods which are analogous to using sampling tubes (i. e. sample collection followed by laboratory analysis) the Aldehyde- and Isocyanate-Sampling-Sets. In this case, a pump draws a specific volume of air onto a fiberglass filter treated with specific compounds. This filter is inside a cassette-type sampler. The flowrate specifications are 0.1 to 1 L/min (aldehyde) and 1 to 2 L/min (isocyanates). The sample volume should be 10 to 100 L (aldehydes) and 20 to 100 L (isocyanates).

During the sampling the aldehydes react with a hydrazine compound to form a stable hydrazone derivate. By using the Isocyanate Sampling Set the isocyanates react with an amine to form a stable urea derivative. After sampling, the loaded fiberglass filters must be stored in a cool place. In the laboratory, the fiberglass filters are analysed with high-performance liquid chromatography. To ensure a recovery rate of greater than 95 %, the filter must be analysed immediately.

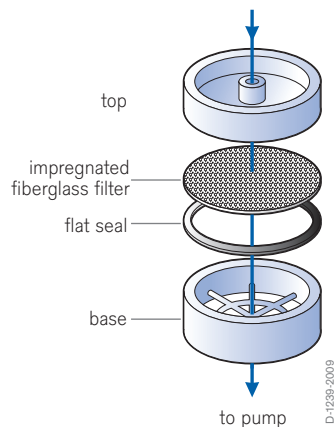

Isocyanate sampler

The detection limits determined by the VDI-Richtlinie 2449 page 1 as absolute units are:

formaldehyde		10 ng
glutardialdehyde		30 ng
toluene diisocyanate	(TDI)	1 ng
diphenylmethane-4,4'-diisocyanate	(MDI)	4 ng
hexamethylene diisocyanate	(HDI)	1 ng

and related to a sampling volume for 20 L:

formaldehyde		0.40 ppb
glutardialdehyde		0.36 ppb
toluene diisocyanate	(TDI)	0.007 ppb
diphenylmethane-4,4'-diisocyanate	(MDI)	0.019 ppb
hexamethylene diisocyanate	(HDI)	0.007 ppb

These methods allows the measurement far below the occupational exposure limits.

2.17 Quality Control for Dräger-Tubes

Dräger-Tubes are normally used for the quantitative determination of contaminants in the air. The need to measure these contaminants may happen on a moments notice. A major advantage of the Dräger-Tube method is its constant state of readiness to provide answers during emergencies or routine monitoring. The extensive quality control program in operation at Dräger Safety AG & Co. KGaA provides the customer of a quality product that can be relied upon time and time again.



Dräger-Tube quality control warehouse

The development, production, and testing of Dräger-Tubes is done within the context of the Dräger quality system, an established company standard. This standard contains as a basic document, the Dräger quality handbook and other detailed quality standards as

performance regulations. The quality control system meets international standards. The fact that the Dräger quality system conforms to the requirements of DIN ISO 9001 was confirmed by an independent institute.

Starting with the basic design idea, through all the detailed development stages, to serial production and eventually full production, Dräger builds quality into its Dräger-Tubes.

To verify the performance of Dräger-Tubes, Dräger takes several packages of each production batch and stores them for routine quality tests at regular intervals.

Detector tube standards were established in various countries to ensure the user that the tubes are indicating properly. The Dräger-Tubes Hydrogene Sulphide 2/a and Carbon Monoxide 5/c were tested as an example by IFA (Institut für Arbeitsschutz der deutschen gesetzlichen Unfallversicherung). Both have a DGUV Tests Certificate.

3. Dräger-Chip-Measurement-System

3.1 The Philosophy of the Chip-Measurement-System Dräger CMS

The production of CMS Analyzer had to be discontinued on the basis of the Directive 2011/65/EU (RoHS II). Chips will remain in the product range.

The Dräger CMS completes the range of existing measuring methods. It combines the practical needs of the user with the power of intelligent technology. It is one of the most accurate and reliable spot measurement systems currently available for measurement of gas and vapor components. The Dräger CMS represents the new standard in the range of various measurement instruments being used in the market.

The Dräger CMS is characterized by many convincing advantages:

- | | |
|---------------------------------|--|
| Simple Operation | <ul style="list-style-type: none"> - simple commands in backlighted display, - system recognizes the measurement task without user input, - identical procedure for all substances, - one-switch operation, - display text available in multiple languages. |
| Accuracy | <ul style="list-style-type: none"> - mass-flow regulated pump (= compensates for pressure fluctuations), - optical measurement and electronic evaluation, - results displayed in digital read out, - well-known and therefore controllable cross sensitivities. |
| Reliability | <ul style="list-style-type: none"> - automatic system self-test, - calibrated chips, - chip shelf life of up to two years, - robust analyzer. |
| Economical | <ul style="list-style-type: none"> - low training costs, - no calibration of chips necessary, - immediately available for measurement (no waiting for warm-up time), - saves time (quick measurements), - high flexibility. |
| Environmentally friendly | <ul style="list-style-type: none"> - fewer materials used in manufacturing, - least possible chemical reagent, - high recycleability of chips. |

3.2 The Components of the Dräger CMS

The Chip-Measurement-System is a system for the quantitative determination of hazardous gas or vapor concentrations in air. The measurements are carried out in the workplace to monitor for hazardous gas concentrations, process control, and for measurements in confined spaces, etc. This system is designed for short-term measurements. The complete measuring system consists of two main key components:

- Substance-Specific Chips
- Analyzer



The Chip-Measurement-System

The Chip-Measurement-System combines the advantages of five components:

- the chip as capillary array for 10 possible measurements,
- optics for detection of the reaction products,
- the pump system with mass-flow controller to draw in ambient air and ensure a constant air mass-flow,
- mechanics designed to position the chip into the analyzer and to open and test the corresponding capillary in preparation for measuring,
- electronics and software to control and regulate the measuring procedure, to process the signal and of course to provide a digital display of the measured concentrations.

3.3 The Chip

Each chip contains ten measurement capillaries filled with a substance-specific reagent system. Compared to other measurement systems, chemical reagent systems have distinct advantages. One reason for this is, that it is possible to supplement the reacting layer with one or more pre-layers to adsorb moisture, to trap interfering substances, or to convert substances into measurable substances. This supports a substance-specific result of the measurement. Furthermore cross-sensitivities can be analyzed and tested in detail. This detailed knowledge provides a means for controlling and correcting for cross-sensitivities. The reactive preparations necessary for detection are kept in hermetically-sealed glass capillaries until needed. The housing of the chip also protects the capillaries from possible external mechanical or chemical influences.

When the chip is inserted into the analyzer, all information required for detection is transferred to the analyzer by means of a bar code:

- type of gas,
- measuring range,
- measuring time,
- parameters for the calibration function,
- required flow rate.

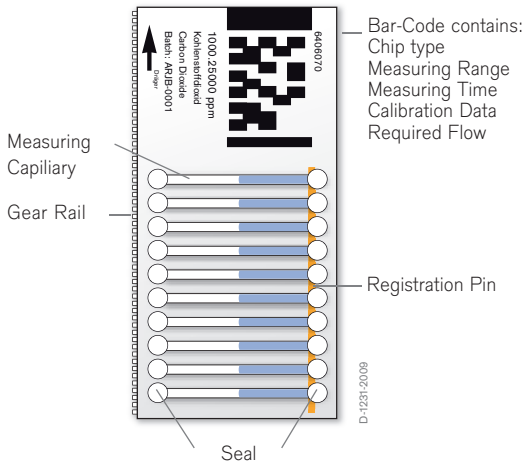

The Chip

The measuring procedure is always the same, so there is no need to remember multiple procedures for different chips. This allows simple and short-time user training and makes working with this new system on a daily basis much easier.

The quantity of reagent used in each capillary is extremely small, resulting in high sensitivity to the measured gas. Furthermore, the use of smaller amounts of active chemicals has a considerable environmental benefit as regards disposal and preparation for re-use - the amount of work involved in this regard has been significantly reduced. The chip housings themselves can be recycled and reused without reprocessing.

3.4 The Analyzer

The analyzer records the measurement effect optoelectronically, thereby eliminating human factors. The gas inlet for the sample air is located at the front of the analyzer and is protected from dust and other impurities. When the integrated mechanics have established an air-tight connection between the entire gas conduction system and the open capillary of the chip, a special pump system pulls a constant mass-flow of air through the capillary.

The pump system consists of a mass-flow-controller, a processor, and a small electric membrane pump. The processor regulates the pump performance for the necessary mass-flow. This combination supports an accurate mass-flow and compensates for fluctuations in the ambient air pressure, within certain limits. No correction of the measurement result is necessary, regardless of whether the measurement is to be carried out at the Dead Sea or in the mountain air of Mexico City.

In the CMS, miniaturization has resulted in a reduction in the sample volume necessary for a measurement. For a typical measurement, only 30 mL of air is needed for a measuring time of approximately two minutes and a mass-flow of 15 mL/min. For shorter measuring times correspondingly less air is needed. This results in a more accurate measurement value which may otherwise be affected by fluctuating concentrations over a longer measurement period.

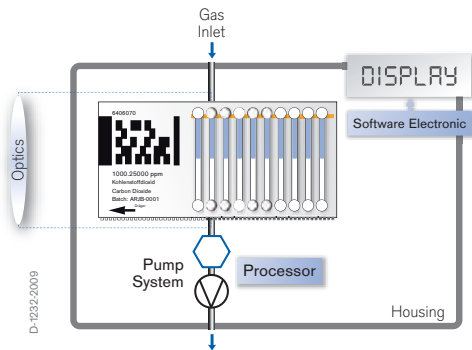

Flow Chart of the Measuring Principle

The capillaries are filled with chemical reagents and filter layers. These ensure a reliable and reproducible response when the corresponding hazardous substance is present, which is one of the main reasons for the high degree of accuracy of the measuring system.

Optoelectronic detectors within the analyzer evaluate the reaction effects in the chip capillary. This has various advantages: small changes in the reaction products can be reliably identified, and measurements can be performed even under conditions of complete darkness, since the measuring signal is electrically processed and indicated in an illuminated display.

The power supply needed for the analyzer to operate is provided by four AA batteries, which have a longer service life than rechargeable batteries on account of their lower self-discharge current.

3.5 The Measurement

The handling of the Dräger CMS is always constant, no matter what gas or vapor is measured. This is provided by simple menu driven commands given by the display as well as the one button/switch operation. The Dräger CMS can be implemented with a minimum of training costs.



Display

The analyzer's most important operating feature is the slide switch positioned symmetrically in the middle. It is symmetrical in order to allow both left and right-handed people to use it with equal ease. The whole measurement is performed using only four switch positions.

Switch Position	Function of the Analyzer
-----------------	--------------------------

0	Device switched off
---	---------------------

1	Switch on analyzer - analyzer immediately performs a complete self-test, followed by the message „function test ok“, displayed for three seconds. Then the message „insert chip“ prompts the user to push the chip selected for the measurement through the rear inlet flap into the analyzer. During this process the analyzer receives information, in the form of a bar code printed on the chip, which is relevant to the measurement: gas type, measuring range, flow and data for the calibration curve.
---	--

The optical system calculates the number of measurements still available on the chip being used, and displays the gas type and the measuring range. Approx. 5 seconds later the user is instructed to set the switch to position 2.

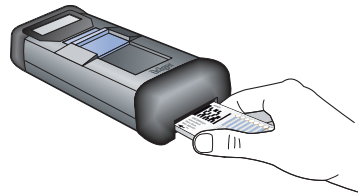

Inserting the chip

ST-1243-2008

2	In this switch position the CMS automatically checks the air-tight integrity of the entire gas conduction system, right up to the chip itself, in order to exclude the occurrence of false measurements due to possible leakages. When the leak test is complete, the switch can be moved to position 3 in order to start the actual measurement process.
---	---

3	Start measurement, both ends of the capillary are open, the pump system pulls ambient air through the measuring capillary of the chips. A bar indicator in the display shows that the measurement is active, until the result of the measurement appears in the display.
---	--

In order to take another test with the same chip, the switch can be moved to position 2 and a new leak test will be conducted.

In order to replace the chip the switch is returned to position 0, the outlet flap opens, the chip is ejected automatically, and the chip can be easily removed.

The Special Feature of Dynamic Dose Measurement

The measurement principle of the CMS is based on a dynamic dose measurement which is dependent on concentration. The basis of this principle is chemical kinetics, whereby the speed of the chemical reaction in the capillary depends on the concentration of the sample. Therefore, the measuring time is not constant, but is directly related to the concentration, i. e. the higher the concentration, the shorter the measuring time. The positioning of the optical unit allows a direct determination of the speed of the chemical reaction within the capillary. Since concentration and reaction speed are directly proportional, the analyzer terminates the measurement very quickly when high concentrations are present.

The safety advantage of the CMS which this provides is of course immediately obvious, as a reduced measuring time at higher concentrations also means a very quick display of the measurement result, thereby providing information about possible gas dangers more quickly. For example, for nitrogen dioxide at a concentration of 5 ppm, there is a standard measuring time of 30 to 35 seconds, whereas for a five-fold value this drops to around 10 to 12 seconds.

3.6 The DataRecorder

The analyzer is equipped with an integrated DataRecorder and a real-time clock. In keeping with the CMS ease-of-use-philosophy, storing measurement results with the DataRecorder is a simple, menu-driven process. Up to 50 measurement results can be stored with the name of the measured substance, the concentration, date and time of the measurement, and a code letter to help identify the measurement location.

3.7 Measurement with the Remote System

Together with the Dräger CMS Analyzer, the Remote System measures various hazardous gases and vapours in inaccessible places such as ducts, shafts or tank systems. The maximum operating time of the analyzer may be reduced by up to 50 %, depending on the operating time of the Remote System.

The Remote System consists of an external pump, which is connected to the Analyzer. It is used together with Dräger extension hoses (length of 3 m or 10 m) or a Dräger telescopic tube (1 m).

Before each measurement, the extension hose or the telescope probe must be flushed with the air sample to be measured. The flushing phase is necessary to minimize or eliminate effects associated with the use of an extension hose (e. g. memory effects, dead volume).

The duration of the flushing phase depends on factors such as:

- type and concentration of the substance to be measured,
- material, length, diameter, and age of the extension hose.

There is no standard flushing time that can be stated that would be valid for all cases. All possible factors affecting the measurement must be considered. Please always refer to the Instructions for Use of the Remote System and the Instructions for Use of the Chips.

The flushing times given in the Instructions for Use have been determined for the specified gas concentrations only. The values refer to the extension hose supplied with the remote System (e. g. length: 3 m, inside diameter: 1.5 m, new, dry, clean) in laboratory conditions.

3.8 Validation of Third Parties

Performance data of each measuring system can be found in the instructions for use. Usually the technical data will be checked by independent institutions. The results will be described from the test organization in a validation report. To date, the Chip-Measurement-System has been tested by the following independent institutions or laboratories:

- Authority for Civil Defence, Germany, Bonn-Bad Godesberg
- Institute of Fire Department Sachsen-Anhalt, Germany, Heyrothsberge
- Clayton Laboratory Services, USA, Detroit
- Austrian Workplace Safety Testing Institute of the Employee's Liability Insurance
- Association, Austria, Vienna

Authority for Civil Defence, Germany

The operation and function of the Dräger CMS were tested. Using the Remote System, measurements against different test gas concentrations were performed. Ten chip-types were checked:

- Ammonia	2	- 50 ppm	- Hydrochloric Acid	20	- 500 ppm
- Ammonia	10	- 150 ppm	- Hydrocyanic Acid	2	- 50 ppm
- Carbon Monoxide	5	- 150 ppm	- Hydrogen Sulfide	2	- 50 ppm
- Chlorine	0.2	- 10 ppm	- Hydrogen Sulfide	20	- 500 ppm
- Hydrochloric Acid	1	- 25 ppm	- Nitrogen Dioxide	0.5	- 25 ppm

The measurement results comply with the performance specifications shown in the instructions for use. The study recommends the Dräger CMS as a robust and easy to use instrument.

Institute of Firedepartment Sachsen Anhalt, Germany

During this study measurements of fires were made in the laboratory and under actual fire-fighting conditions. Based on the results of this study, the institute recommends the Chip-Measurement-System for the measurement of hazardous gases and vapors.

Clayton Laboratory Services, USA

The Dräger CMS was tested using benzene at two concentrations (1 ppm and 4 ppm). The accuracy and reproducibility of the measuring system was within the values given in the instructions for use.

Measuring results	Clayton Laboratory		Dräger Laboratory		Instructions for use
Concentration	1 ppm	4 ppm	1 ppm	4 ppm	0.2 - 10 ppm
Accuracy	± 4.4%	± 7.3%	- 1 %	5 %	± 18 %
Reproducibility	± 9.9%	± 8.2%	15 %	11 %	± 25 %

Chip: Benzene 0.2-10 ppm

Order-Code: 64 06 030

Batch-No.: ARLM-0611

Austrian Workplace Safety Testing Institute of the Employee's Liability Insurance Association, Austria

The intention of the study was a practice-oriented test of the Dräger CMS in varying conditions of temperature, humidity, and concentration. The measuring results of the Dräger CMS measurements were compared with reference methods.

Different chip-types were checked in a brewery and a thermal spring / bath:

- Carbon Dioxide 1,000 to 25,000 ppm
- Carbon Dioxide 1 to 20 Vol.-%
- Hydrogen Sulfide 2 to 50 ppm

The basis of this validation was the Austrian standard EN 482: "Workplace Atmospheres – General Requirements for Methods of Measuring Chemical Agents".

The institute confirms:

- The measuring results of the Dräger CMS correspond with the results of the reference methods.
- The accuracy of the Dräger CMS is far higher than the required accuracy of the standard EN 482.
- The Dräger CMS is a suitable measurement system.

3.9 Performance Data of the Dräger CMS

Measuring Range	depends on the chip type
Typical Measuring Time	20 seconds to 3 minutes (depends on the chip type and the concentration of hazardous gas to be measured) 20 seconds to 10 minutes with special hazardous gas
Calibration	by manufacturer
Temperature (operation)	0 to 40 °C (32 to 104 °F)
Temperature (storage)	- 20 to 60 °C (- 4 to 140 °F) (Analyzer) < 25 °C (< 77 °F) (Chips)
Atmospheric Pressure	700 to 1,100 hPa
Relative Humidity	0 to 95 %, not condensing
System Diagnosis	automatic self-diagnosis, microprocessor controlled for all components of the system
Display	LCD, alphanumerical digits, backlight
Menu Languages	English, German, French, Spanish
Operational Time	approx. 450 minutes of measurements (per battery pack)
Power Supply	4 x 1.5-V-batteries, only use the following types: Ralsten (Energizer) Alkaline LR6 Duracell MN 1500 LR6 Rayovac Rechargeable Alkaline AA (only to use with Rayovac Charger PS1 or PS3)
Weight	730 g (1.6 lbs., analyzer with batteries)
Dimensions	215 x 105 x 65 mm; 8.5" x 4.1" x 2.5" (L x W x H)
Electromagnetic Interference EMV	EN 550 11; by 10/01 EN 502 70
Radio Frequency Interference RFI	EN 550 14
Ingress Protection	IP 54

3.10 Approvals

Approvals / Certifications for Analyzer Set (Order code 64 05 300):

ATEX,

BVS 03 ATEX E 209 X

UL USA,

Class 1, Div 1, Groups A, B, C, D, Temp. Code T4, 2P911

UL Canada,

Class 1, Div 1, Groups A, B, C, D, Temp. Code T4, 2P911

CSA Canada,

Class 1, Div 1, Groups A, B, C, D, Ex ia Temp. Code T4

4. Overview of the Dräger-Tubes and Chip-Measurement-System

4.1 Dräger-Tube Pumps and Systems

Dräger-Tube pump accuro with Dräger-Tube opener TO 7000	64 00 000
Dräger-Tube pump set accuro	64 00 260
Soft Gas Detection Set	83 17 186
MDG Kit	83 18 392
Dräger accuro spare parts set	64 00 220
Extension hose Dräger accuro & Dräger X-act 5000, 1 m	64 00 561
Extension hose Dräger accuro & Dräger X-act 5000, 3 m	64 00 077
Extension hose Dräger accuro & Dräger X-act 5000, 10 m	64 00 078
Extension hose Dräger accuro & Dräger X-act 5000, 15 m	64 00 079
Extension hose, 30 m for Dräger X-act 5000	64 00 175
Dräger X-act 5000	45 23 500
Alkalinebattery pack w/o battery	45 23 525
Alkalinebattery, 6 pc. needed	81 03 594
NiMHy Battery, T4	45 23 520
Wall-Wart Charger 100-240 Vac	45 23 545
Car Charger 12/24V	45 23 511
SO ₃ Filter Replacement	81 03 525
Case, orange, without contents	83 17 147
Hot air probe	CH 00 213
Vehicle exhaust probe	CH 00 214
Probe 400	83 17 188
Dräger-Tube opener TO 7000	64 01 200
Hot pack holder, complete	83 16 130
Hot packs (2 pieces)	83 16 139
DLE-Set Dräger Liquid Extraction set	64 00 030
Dräger Aerotest for measurement of air, medical gases and carbon dioxide:	
Dräger Aerotest 5000	64 01 220
Dräger Aerotest Alpha, complete	65 27 150
Dräger MultiTest med. Int, complete	65 20 260
Dräger Simultaneoustest CO ₂ , complete	65 26 170
Dräger Aerotest Simultaneous HP, complete	65 25 951
Dräger Aerotest Navy, complete	65 25 970
Impactor for measurement of oil mist in compressed air	81 03 560
Adapter for Dräger Oil-Impactor	81 03 557

4.2 Dräger-Tubes for Short-Term Measurements

Dräger-Tubes	Order Code	Standard Range of Measurement [20 °C, 1013 hPa]	Measurement Time [min]	Page
Acetaldehyde 100/a	67 26 665	100 to 1000 ppm	5	102
Acetic Acid 5/a	67 22 101	5 to 80 ppm	30 s	103
Acetone 40/a	81 03 381	40 to 800 ppm	1	104
Acetone 100/b	CH 22 901	100 to 12000 ppm	4	105
Acid Test	81 01 121	qualitative	3 s	106
Acrylonitrile 0.2/a	81 03 701	0.2 to 4 ppm 5 to 50 ppm	4 1	107
Activation tube for use in conjunction with Formaldehyde 0.2/a tube	81 01 141			
Amine Test	81 01 061	qualitative	5 s	109
Ammonia 0.25/a	81 01 711	0.25 to 3 ppm	1	109
Ammonia 2/a	67 33 231	2 to 30 ppm	1	110
Ammonia 5/a	CH 20 501	5 to 70 ppm 50 to 600 ppm	1 10 s	111
Ammonia 5/b	81 01 941	5 to 100 ppm	10 s	112
Ammonia 0.5%/a	CH 31 901	0.5 to 10 Vol%	20 s	113
Aniline 0.5/a	67 33 171	0.5 to 10 ppm	4	114
Aniline 5/a	CH 20 401	1 to 20 ppm	3	115
Arsine 0.05/a	CH 25 001	0.05 to 3 ppm	6	116
Benzene 0.25/a	81 03 691	0.25 to 2 ppm 2 to 10 ppm	5 1	117
Benzene 1/a	81 03 641	1 ppm Benzene	3	118
Benzene 2/a (5)	81 01 231	2 to 60 ppm	8	119
Benzene 5/a	67 18 801	5 to 40 ppm	3	120
Benzene 5/b	67 28 071	5 to 50 ppm	8	121
Benzene 15/a	81 01 741	15 to 420 ppm	4	122
n-Butanol 10/a	81 03 861	10 to 250 ppm 250 to 2000 ppm	6	123
Carbon Dioxide 100/a	81 01 811	100 to 3000 ppm	4	124

Dräger-Tubes	Order Code	Standard Range of Measurement [20 °C, 1013 hPa]	Measurement Time [min]	Page
Carbon Dioxide 0.1%/a	CH 23 501	0.5 to 6 Vol% 0.1 to 1.2 Vol%	30 s 2.5	125
Carbon Dioxide 0.5%/a	CH 31 401	0.5 to 10 Vol%	30 s	126
Carbon Dioxide 1%/a	CH 25 101	1 to 20 Vol%	30 s	127
Carbon Dioxide 5%/A	CH 20 301	5 to 60 Vol%	2	128
Carbon Disulfide 3/a	81 01 891	3 to 95 ppm	2	129
Carbon Disulfide 5/a	67 28 351	5 to 60 ppm	3	130
Carbon Disulfide 30/a	CH 23 201	0.1 to 10 mg/L	1	131
Carbon Monoxide 2/a	67 33 051	2 to 60 ppm	4	132
Carbon Monoxide 5/c	CH 25 601	100 to 700 ppm 5 to 150 ppm	30 s 150 s	133
Carbon Monoxide 8/a	CH 19 701	8 to 150 ppm	2	134
Carbon Monoxide 10/b	CH 20 601	100 to 3000 ppm 10 to 300 ppm	20 s 4	135
Carbon Monoxide 0.3%/b	CH 29 901	0.3 to 7 Vol%	30 s	136
Carbon Tetrachloride 0.1/a	81 03 501	0.1 to 5 ppm	2.5	137
Carbon Tetrachloride 1/a	81 01 021	1 to 15 ppm 10 to 50 ppm	6 3	138
Chlorine 0.2/a	CH 24 301	0.2 to 3 ppm 3 to 30 ppm	3 30 s	139
Chlorine 0.3/b	67 28 411	0.3 to 5 ppm	8	140
Chlorine 50/a	CH 20 701	50 to 500 ppm	20 s	141
Chlorine Dioxide 0.025/a	81 03 491	0.025 to 1 ppm 0.1 to 1 ppm	7.5 2.5	142
Chlorobenzene 5/a (5)	67 28 761	5 to 200 ppm	3	143
Chloroform 2/a (5)	67 28 861	2 to 10 ppm	9	144
Chloroformate 0.2/b	67 18 601	0.2 to 10 ppm	3	145
Chloropicrine 0.1/a	81 03 421	0.1 to 2 ppm	7.5	146
Chloroprene 5/a	67 18 901	5 to 60 ppm	3	147
Chromic Acid 0.1/a (9)	67 28 681	0.1 to 0.5 mg/m ³	8	148
Cyanide 2/a	67 28 791	2 to 15 mg/m ³	2.5	149
Cyanogen Chloride 0.25/a	CH 19 801	0.25 to 5 ppm	5	150
Cyclohexane 40/a	81 03 671	40 to 200 ppm 300 to 3000 ppm	75 s 15 s	151
Cyclohexylamine 2/a	67 28 931	2 to 30 ppm	4	152
Diesel Fuel	81 03 475	25 to 200 mg/m ³	30 s	153

Dräger-Tubes	Order Code	Standard Range of Measurement [20 °C, 1013 hPa]	Measurement Time [min]	Page
Diethyl Ether 100/a	67 30 501	100 to 4000 ppm	3	154
Dimethyl Formamide 10/b	67 18 501	10 to 40 ppm	3	155
Dimethyl Sulfate 0.005/c (9)	67 18 701	0.005 to 0.05 ppm	50	156
Dimethyl Sulfide 1/a (5)	67 28 451	1 to 15 ppm	15	157
Epichlorhydrine 5/c	67 28 111	5 to 80 ppm	8	158
Ethanol 100/a	81 03 761	100 to 3000 ppm	1.5	159
Ethyl Acetate 200/a	CH 20 201	200 to 3000 ppm	5	160
Ethyl Benzene 30/a	67 28 381	30 to 400 ppm	2	161
Ethyl Glycol Acetate 50/a	67 26 801	50 to 700 ppm	3	162
Ethylene 0.1/a (5)	81 01 331	0.2 to 5 ppm	30	163
Ethylene 50/a	67 28 051	50 to 2500 ppm	6	164
Ethylene Glycol 10 (5)	81 01 351	10 to 180 mg/m ³	7	165
Ethylene Oxide 1/a (5)	67 28 961	1 to 15 ppm	8	166
Ethylene Oxide 25/a	67 28 241	25 to 500 ppm	6	167
Fluorine 0.1/a	81 01 491	0.1 to 2 ppm	5	168
Formaldehyde 0.2/a	67 33 081	0.2 to 2.5 ppm	20	
		0.5 to 5 ppm	1.5	169
Activation tube for use in conjunction with Formaldehyde 0.2/a tube	81 01 141			
Formaldehyde 2/a	81 01 751	2 to 40 ppm	30 s	170
Formic Acid 1/a	67 22 701	1 to 15 ppm	3	171
Halogenated Hydrocarbons 100/a (8)	81 01 601	100 to 2600 ppm	1	172
Hexane 10/a	81 03 681	10 to 200 ppm	75 s	173
		300 to 2500 ppm	15 s	
Hydrazine 0.01/a	81 03 351	0.01 to 0.4 ppm	30	174
		0.5 to 6 ppm	1	
Hydrazine 0.25/a	CH 31 801	0.25 to 10 ppm	1	175
		0.1 to 5 ppm	2	
Hydrocarbons 2/a	81 03 581	2 to 24 mg/m ³	5	176
Hydrocarbons 0.1%/c	81 03 571	0.1 to 1.3 Vol.-%Propane		177
		0.1 to 1.3 Vol.-%Butane		
		0.1 to 1.3 Vol.-%mix 1:1		
Hydrochloric Acid 0.2/a	81 03 481	0.2 to 3 ppm	2	178
		3 to 20 ppm	40 s	

Dräger-Tubes	Order Code	Standard Range of Measurement [20 °C, 1013 hPa]	Measurement Time [min]	Page
Hydrochloric Acid 1/a	CH 29 501	1 to 10 ppm	2	179
Hydrochloric Acid 50/a	67 28 181	500 to 5000 ppm	30 s	180
		50 to 500 ppm	4	
Hydrochloric Acid/Nitric Acid 1/a	81 01 681			181
Hydrochloric Acid		1 to 10 ppm	1.5	
Nitric Acid		1 to 15 ppm	3	
Hydrocyanic Acid 0.5/a	81 03 601	0.5 to 5 ppm	2.5	182
		5 to 50 ppm	0.5	
Hydrogen 0.2%/a	81 01 511	0.2 to 2.0 Vol%	1	183
Hydrogen 0.5%/a	CH 30 901	0.5 to 3.0 Vol%	1	184
Hydrogen Fluoride 0.5/a	81 03 251	0.5 to 15 ppm	2	185
		10 to 90 ppm	25 s	
Hydrogen Fluoride 1.5/b	CH 30 301	1.5 to 15 ppm	2	186
Hydrogen Peroxide 0.1/a	81 01 041	0.1 to 3 ppm	3	187
Hydrogen Sulfide 0.2/a	81 01 461	0.2 to 5 ppm	5	188
Hydrogen Sulfide 0.2/b	81 01 991	0.2 to 6 ppm	55 s	189
Hydrogen Sulfide 0.5/a	67 28 041	0.5 to 15 ppm	6	190
Hydrogen Sulfide 1/c	67 19 001	10 to 200 ppm	20 s	191
		1 to 20 ppm	3	
Hydrogen Sulfide 1/d	81 01 831	10 to 200 ppm	1	192
		1 to 20 ppm	10	
Hydrogen Sulfide 2/a	67 28 821	20 to 200 ppm	20 s	193
		2 to 20 ppm	3.5	
Hydrogen Sulfide 2/b	81 01 961	2 to 60 ppm	30 s	194
Hydrogen Sulfide 5/b	CH 29 801	5 to 60 ppm	4	195
Hydrogen Sulfide 100/a	CH 29 101	100 to 2000 ppm	30 s	196
Hydrogen Sulfide 0.2%/A	CH 28 101	0.2 to 7 Vol%	2	197
Hydrogen Sulfide 2%/a	81 01 211	2 to 40 Vol%	1	198
Simultaneous Tube	CH 28 201	0.2 to 7 Vol%	2	199
Hydrogen Sulfide + Sulfur Dioxide 0.2%/A				199
Iodine 0.1/a	81 03 521	1 to 5 ppm	5	200
		0.1 to 0.6 ppm	4	
Mercaptan 0.1/a	81 03 281	0.1 to 2.5 ppm	3	201
		3 to 15 ppm	40 s	

Dräger-Tubes	Order Code	Standard Range of Measurement [20 °C, 1013 hPa]	Measurement Time [min]	Page
Mercaptan 0.5/a	67 28 981	0.5 to 5 ppm	5	202
Mercaptan 20/a	81 01 871	20 to 100 ppm	2.5	203
Mercury Vapour 0.1/b	CH 23 101	0.05 to 2 mg/m ³	10	204
Methanol 20/a	81 03 801	20 to 250 ppm	6	205
		200 to 5000 ppm	2	
Methyl Acrylate 5/a	67 28 161	5 to 200 ppm	5	206
Methyl Bromide 0,2/a	81 03 391	0.2 to 2 ppm	8	207
		2 to 8 ppm	4	
Methyl Bromide 0.5/a	81 01 671	5 to 30 ppm	2	208
		0.5 to 5 ppm	5	
Methyl Bromide 3/a (5)	67 28 211	10 to 100 ppm	1	209
		3 to 35 ppm	2.5	
Methyl Bromide 5/b	CH 27 301	5 to 50 ppm	1	210
Methylene Chloride 20/a	81 03 591	20 to 200 ppm	7	211
Natural Gas Test (5)	CH 20 001	qualitative	100 s	212
Nickel Tetracarbonyl 0.1/a (9)	CH 19 501	0.1 to 1 ppm	5	213
Nitric Acid 1/a	67 28 311	5 to 50 ppm	2	214
		1 to 15 ppm	4	
Nitrogen Dioxide 0.1/a	81 03 631	5 to 30 ppm	15 s	215
		0.1 to 5 ppm	75 s	
Nitrogen Dioxide 2/c	67 19 101	5 to 100 ppm	1	216
		2 to 50 ppm	2	
Nitrous Fumes 0,2/a	81 03 661	0.2 to 6 ppm	40 s	217
		5 to 30 ppm	30 s	
Nitrous Fumes 2/a	CH 31 001	5 to 100 ppm	1	218
		2 to 50 ppm	2	
Nitrous Fumes 20/a	67 24 001	20 to 500 ppm	30 s	219
Nitrous Fumes 50/b	81 03 941	50 to 1000 ppm	120 s	220
		2000 to 4000 ppm	60 s	
Oil Mist 1/a	67 33 031	1 to 10 mg/m ³	25	221
Olefine 0.05%/a	CH 31 201		5	222
Propylene		0.06 to 3.2 Vol%		
Butylene		0.04 to 2.4 Vol%		
Organic Arsenic Compounds and Arsine	CH 26 303	0.3mg/m ³ as AsH ₃	3	

Dräger-Tubes	Order Code	Standard Range of Measurement [20 °C, 1013 hPa]	Measurement Time [min]	Page
Organic Basic Nitrogen Compounds	CH 25 903	1mg/m ³ threshold value	1.5	
Oxygen 5%/B (8)	67 28 081	5 to 23 Vol%	1	223
Oxygen 5%/C	81 03 261	5 to 23 Vol%	1	224
Ozone 0.05/b	67 33 181	0.05 to 0.7 ppm	3	225
Ozone 10/a	CH 21 001	20 to 300 ppm	20 s	226
Pentane 100/a	67 24 701	100 to 1500 ppm	15 s	227
Perchloroethylene 0.1/a	81 01 551	0.5 to 4 ppm	3	228
		0.1 to 1 ppm	9	
Perchloroethylene 2/a	81 01 501	20 to 300 ppm	30 s	229
		2 to 40 ppm	3	
Perchloroethylene 10/b	CH 30 701	10 to 500 ppm	40 s	230
Petroleum Hydrocarbons 10/a	81 01 691	10 to 300 ppm	1	231
Petroleum Hydrocarbons 100/a	67 30 201	100 to 2500 ppm	30 s	232
Phenol 1/b	81 01 641	1 to 20 ppm	5	233
Phosgene 0.02/a	81 01 521	0.02 to 1 ppm	6	234
		0.02 to 0.6 ppm	12	
Phosgene 0.05/a	CH 19 401	0.04 to 1.5 ppm	11	235
Phosgene 0.25/c	CH 28 301	0.25 to 5 ppm	1	236
Phosphine 0.01/a	81 01 611	0.01 to 0.3 ppm	8	237
		0.1 to 1.0 ppm	2.5	
Phosphine 0.1/c	81 03 711	0.5 to 3 ppm	1	238
		0.1 to 1.0 ppm	2.5	
Phosphine 0.1/b in Acetylene	81 03 341	1 to 15 ppm	20 s	239
		0.1 to 1 ppm	4	
Phosphine 1/a	81 01 801	10 to 100 ppm	2	240
		1 to 20 ppm	10	
Phosphine 25/a	81 01 621	200 to 10000 ppm	1.5	241
		25 to 900 ppm	13	
Phosphine 50/a	CH 21 201	50 to 1000 ppm	2	242
Phosphoric Acid Esters 0.05/a	67 28 461	0.05 ppm Dichlorvos	5	294
Polytest	CH 28 401	qualitative	1.5	243
i-Propanol 50/a	81 03 741	50 to 4000 ppm	2.5 min	244
Pyridine 5/A	67 28 651	5 ppm	20	245
Styrene 10/a	67 23 301	10 to 200 ppm	3	246

Dräger-Tubes	Order Code	Standard Range of Measurement [20 °C, 1013 hPa]	Measurement Time [min]	Page
Styrene 10/b	67 33 141	10 to 250 ppm	3	247
Styrene 50/a	CH 27 601	50 to 400 ppm	2	248
Sulfuryl Fluoride 1/a (5)	81 03 471	1 to 5 ppm	3	249
Sulfur Dioxide 0.1/a	67 27 101	0.1 to 3 ppm	20	250
Sulfur Dioxide 0.5/a	67 28 491	1 to 25 ppm	3	251
		0.5 to 5 ppm	6	
Sulfur Dioxide 1/a	CH 31 701	1 to 25 ppm	3	252
Sulfur Dioxide 20/a	CH 24 201	20 to 200 ppm	3	253
Sulfur Dioxide 50/b	81 01 531	400 to 8000 ppm	15 s	254
		50 to 500 ppm	3	
Sulfuric Acid 1/a (9)	67 28 781	1 to 5 mg/m ³	100	255
Tertiary Butylmercaptan	81 03 071	1 to 10 mg/m ³	5	256
		(natural gas odorization)		
Tetrahydrothiophene 1/b (5)	81 01 341	1 to 10 ppm	10	257
Thioether	CH 25 803	1 mg/m ³ threshold value	1.5	258
Toluene 5/b	81 01 661	50 to 300 ppm	2	259
		5 to 80 ppm	10	
Toluene 50/a	81 01 701	50 to 400 ppm	1.5	260
Toluene 100/a	81 01 731	100 to 1800 ppm	1.5	261
Toluene Diisocyanate 0.02/A (9)	67 24 501	0.02 to 0.2 ppm	20	262
Trichloroethane 50/d (5)	CH 21 101	50 to 600 ppm	2	263
Trichloroethylene 2/a	67 28 541	20 to 250 ppm	1.5	264
		2 to 50 ppm	2.5	
Trichloroethylene 50/a	81 01 881	50 to 500 ppm	1.5	265
Triethylamine 5/a	67 18 401	5 to 60 ppm	2	266
Vinyl Chloride 0.5/b	81 01 721	5 to 30 ppm	30 s	267
		0.5 to 5 ppm	3	
Vinyl Chloride 100/a	CH 19 601	100 to 3000 ppm	4	268
Water Vapor 0.1	CH 23 401	1 to 40 mg/L	2	269
Water Vapor 0.1/a	81 01 321	0.1 to 1.0 mg/L	1.5	271
Water Vapor 1/b	81 01 781	20 to 40 mg/L	20 s	272
		1 to 18 mg/L	40 s	
Water Vapor 3/a	81 03 031	3.0 to 60 lbs/mmcf	90 s	270
Xylene 10/a	67 33 161	10 to 400 ppm	1	273

4.3 Dräger-Tubes for Measurements in Liquid Samples

Substance	Measuring Range [1013 hPa]	Dräger-Tubes	Order Code
Inorganic Substances			
Ammonia	1.5 - 10 mg/L	Ammonia 0.25/a	81 01 711
	10 - 100 mg/L	Ammonia 0.25/a	81 01 711
Hydrocyanic Acid	0.5 - 10 mg/L	Hydrocyanic Acid 0.5/a	81 06 601
Hydrogen Sulfide (total sulfide)	50 - 500 µg/L	Hydrogen Sulfide 0,2/a	81 01 461
	0.2 - 1 mg/L	Hydrogen Sulfide 1/c	67 19 001
	0.5 - 10 mg/L	Hydrogen Sulfide 5/b	CH 29 801
Aliphatic hydrocarbons			
Petroleum Hydrocarbons	0.5 - 30 mg/L	Petroleum Hydrocarbons 10/a	81 01 691
Diesel fuels	0.5 - 5 mg/L	Petroleum Hydrocarbons 10/a	81 01 691
Jet fuels	0.5 - 5 mg/L	Petroleum Hydrocarbons 10/a	81 01 691
n-Octane	0.1 - 2 mg/L	Petroleum Hydrocarbons 10/a	81 01 691
	2 - 25 mg/L	Petroleum Hydrocarbons 100/a	67 30 201
Aromatic hydrocarbons			
Benzene	0.5 - 5 mg/L	Benzene 2/a	81 01 231
Toluene	1 - 10 mg/L	Toluene 50/a	81 01 701
Xylene (o, m, p)	0.3 - 10 mg/L	Xylene10/a	67 33 161
BTX-Aromatics	0.2 - 5 mg/L	Toluene 5/b	81 01 161
BTX-Aromatics (soil analysis)	2 - 50 mg/Kg	Toluene 5/b	81 01 161
Halogenated hydrocarbons (volatile)			
Soil analysis	qualitative	Perchloroethylene 0,1/a	81 01 551
	qualitative	Perchloroethylene 2/a	81 01 501
Multiphase system	qualitative	Methyl Bromide 0,5/a	81 01 671
	qualitative	Perchloroethylene 0,1/a	81 01 551
	qualitative	Perchloroethylene 2/a	81 01 501
	qualitative	Trichloroethane 50/d	CH 21 101
Oil muds / -emulsions	qualitative	Methyl Bromide 0,5/a	81 01 671
	qualitative	Perchloroethylene 0,1/a	81 01 551
	qualitative	Perchloroethylene 2/a	81 01 501
	qualitative	Trichloroethane 50/d	CH 21 101

Substance	Measuring Range [1013 hPa]	Dräger-Tubes	Order Code
Chlorinated hydrocarbons (volatile)			
Perchloroethylene	10 - 80 µg/L	Perchloroethylene 0,1/a	81 01 551
	0.1 - 4 mg/L	Perchloroethylene 2/a	81 01 501
1,1,1-Trichloroethane	0.5 - 5 mg/L	Trichloroethane 50/d	CH 21 101
Trichloroethylene	10 - 100 µg/L	Perchloroethylene 0,1/a	81 01 551
	0.1 - 1 mg/L	Perchloroethylene 2/a	81 01 501
	0.2 - 3 mg/L	Trichloroethylene 2/a	67 28 541
Organic acids			
Acetic acid	0.5 - 20 g/L	Acetic acid 5/a	67 22 101
Formic acid	1 - 20 g/L	Acetic acid 5/a	67 22 101
Organic acids (sumparameter)	0.5 - 15 g/L	Acetic acid 5/a	67 22 101
Propionic acid	0.3 - 10 g/L	Acetic acid 5/a	67 22 101

4.4 Dräger-Diffusion-Tubes with Direct Indication

Dräger-Tube	Order Code	Standard Range of Meas. for 1 h [20 °C, 1013 hPa]	Standard Range of Meas. for 8 h [20 °C, 1013 hPa]	Page
Ammonia 20/a-D	81 01 301	20 to 1500 ppm	2.5 to 200 ppm	354
Butadiene 10/a-D	81 01 161	10 to 300 ppm	1.3 to 40 ppm	355
Carbon Dioxide 500/a-D	81 01 381	500 to 20000 ppm	65 to 2500 ppm	356
Carbon Dioxide 1%/a-D	81 01 051	1 to 30 Vol%	0.13 to 4 Vol%	357
Carbon Monoxide 50/a-D	67 33 191	50 to 600 ppm	6 to 75 ppm	358
Nitrogen Dioxide 10/a-D	81 01 111	10 to 200 ppm	1.3 to 25 ppm	360

4.5 Dräger-Sampling-Tubes and Systems

Dräger-Tube	Order Code	Page
Activated Charcoal Tubes Type B	67 33 011	363
Activated Charcoal Tubes Type G	67 28 831	364
Activated Charcoal Tubes Type NIOSH	67 28 631	365
Activated Charcoal Tubes Type B/G	81 01 821	362
Aldehyde-Sampling-Set	64 00 271	366
Sampling Tubes Amines	81 01 271	367
Isocyanate-Sampling-Set	64 00 131	368
Nitrous-Oxide Diffusion Sampler	81 01 472	369
Diffusion Sampler ORSA 5	67 28 891	370
Silica Gel Tubes Type BIA	67 33 021	371
Silica Gel Tubes Type G	67 28 851	372
Silica Gel Tubes Type NIOSH	67 28 811	373

4.6 Overview of Substances for Measurement with Dräger-Sampling-Tubes and Systems

Substance	ORSA	Activated Charcoal	Silica Gel	Amine	Other
Acetic Acid, Amyl Ester		X			
Acetic Acid, Butyl Ester	X	X			
Acetic Acid, Ethyl Ester	X	X			
Acetic Acid, sec-Hexyl Ester	X	X			
Acetic Acid, Methyl Ester	X	X			
Acetic Acid Propyl Ester	X	X			
Acetic Acid, Vinyl Ester	X	X			
Acetone	X	X			
Acetonitrile	X	X			
Acrolein					A4
Acrylic Acid, Ethyl Ester	X	X			
Acrylic Acid, Methyl Ester	X	X			
Acrylonitrile	X	X			
Allyl Alcohol		X			
Allyl Chloride	X	X			
Amine (aliphatic)				X	
Aminobutane (all isomers)				X	
Aminocyclohexane				X	
2-Aminoethanol				X	
2-Aminopropane				X	
Amyl Acetate	X	X			
iso-Amyl Alcohol	X	X			
Aniline			X		
Benzene	X	X			
Bromochlorotrifluoroethane	X	X			
2-Bromo-2-chloro-1,1,1-trifluoroethane	X	X			
Bromoethane	X	X			
Bromoform	X	X			
Bromomethane	X	X			
1,3-Butadiene	X	X			
Butanol (all isomers)	X	X			
2-Butanone	X	X			
1-Butoxy-2,3-epoxypropane		X			
2-Butoxyethanol	X	X			
Butyl Acetate (all isomers)	X	X			

Substance	ORSA	Activated Charcoal	Silica Gel	Amine	Other
n-Butyl Acrylate	X	X			
Butyl Alcohol	X	X			
Butylamine (all isomers)				X	
p-tert-Butyltoluene	X	X			
Camphor		X			
Carbon Bisulfide		X			
Carbon Disulfide	X	X			
Carbon Tetrachloride	X	X			
Chlorobenzene	X	X			
Chlorobromomethane	X	X			
2-Chloro-1,3-butadiene	X	X			
1-Chloro-2,3-epoxypropane	X	X			
Chloroethane	X	X			
2-Chloroethanol	X	X			
bis-(2-Chloroethyl) Ether	X	X			
Chloroform	X	X			
Chloromethane		X			
2-Chloroprene	X	X			
3-Chloropropene	X	X			
3-Chloro-1-propene	X	X			
2-Chlorotoluene	X	X			
2-Chloro-1,1,2-trifluoroethyl (difluoromethyl)-ether	X	X			
1-Chloro-2,2,2-trifluoroethyl (difluoromethyl)-ether	X	X			
Cresol (all isomers)			X		
Cumene	X	X			
Cyclohexane	X	X			
Cyclohexanol		X			
Cyclohexanone	X	X			
Cyclohexene	X	X			
Cyclohexylamine				X	
Diacetone Alcohol		X			
1,2-Diaminoethane				X	
1,2-Dibromomethane	X	X			

Substance	ORSA	Activated Charcoal	Silica Gel	Amine	Other
1,2-Dichlorobenzene	X	X			
1,4-Dichlorobenzene	X	X			
o-Dichlorobenzene	X	X			
p-Dichlorobenzene	X	X			
2,2-Dichlorodiethyl Ether	X	X			
Dichlorodifluoromethane	X	X			
1,1-Dichloroethane	X	X			
1,2-Dichloroethane	X	X			
1,1-Dichloroethylene	X	X			
1,2-Dichloroethylene	X	X			
Dichlorofluoromethane	X	X			
Dichloromethane	X	X			
1,1-Dichloro-1-nitroethane	X	X			
1,2-Dichloropropane	X	X			
1,2-Dichloro-1,1,2,2-tetrafluoroethane	X	X			
Diethylamine				X	
Diethyl Ether	X	X			
Diethyl Sulfate				X	
Difluorobromomethane	X	X			
Difluorodibromomethane	X	X			
Difluoromonochloromethane	X	X			
Diisobutyl Ketone	X	X			
Diisopropyl Ether	X	X			
Dimethylamine				X	
N,N-Dimethylaniline		X			
Dimethylbenzene	X	X			
1,3-Dimethylbutyl Acetate	X	X			
1,1-Dimethylethylamine				X	
N,N-Dimethylethylamine				X	
Dimethylformamide				X	
Dimethyl Sulfate				X	
1,4-Dioxane	X	X			
Diphenyl Ether (vapour)		X			
Diphenylmethane-4,4'-diisocyanate					I1
4,4'-Diphenylmethane Diisocyanate					I1

Substance	ORSA	Activated Charcoal	Silica Gel	Amine	Other
Enflurane	X	X			
Epichlorohydrin	X	X			
1,2-Epoxypropane		X			
1,2-Ethanediol	X	X			
Ethanol	X	X			
Ethanolamine				X	
Ether	X	X			
2-Ethoxyethanol	X	X			
2-Ethoxyethyl Acetate	X	X			
Ethyl Acetate	X	X			
Ethyl Acrylate	X	X			
Ethyl Alcohol	X	X			
Ethylamine				X	
Ethylbenzene	X	X			
Ethyl Bromide	X	X			
Ethyl Chloride	X	X			
Ethylene Chloride	X	X			
Ethylene Chlorohydrin	X	X			
Ethylenediamine				X	
Ethylene Dibromide	X	X			
Ethylene Dichloride	X	X			
Ethylene Glycol	X	X			
Ethylene Glycol Mono- butyl Ether	X	X			
butyl Ether Acetate	X	X			
ethyl Ether	X	X			
ethyl Ether Acetate	X	X			
methyl Ether	X	X			
methyl Ether Acetate	X	X			
Ethylene Oxide	X	X			
Ethyl Ether	X	X			
Ethyl Formate	X	X			
Ethyl Glycol Acetate	X	X			
Ethyl Methyl Ketone	X	X			
Fluorotrichloromethane		X			

Substance	ORSA	Activated Charcoal	Silica Gel	Amine	Other
Formaldehyde			X		A4
Formic Acid Ethyl Ester	X	X			
Gasoline	X	X			
Glutaraldehyde					A4
Halothane	X	X			
HDI					I1
Heptane (all isomers)	X	X			
Hexachloroethane	X	X			
1,6-Hexamethylene Diisocyanate					I1
Hexamethylene Diisocyanate					I1
Hexane	X	X			
2-Hexanone	X	X			
Hexone	X	X			
sec-Hexyl Acetate	X	X			
Hydrazine					H3
4-Hydroxy-4-methylpentanone-2		X			
Iodomethane		X			
Isoamyl Alcohol	X	X			
Isocyanate					I1
Isoflurane	X	X			
Isophorone		X			
Isopropenyl Benzene	X	X			
Isopropyl Acetate	X	X			
Isopropyl Alcohol	X	X			
Isopropylamine				X	
Isopropylbenzene	X	X			
Isopropyl Ether	X	X			
Laughing Gas					L2
MDI					I1
Mesityl Oxide	X	X			
Methanol			X		
2-Methoxyethanol	X	X			
2-Methoxyethyl Acetate	X	X			
Methyl Acetate	X	X			
Methyl Acrylate	X	X			

Substance	ORSA	Activated Charcoal	Silica Gel	Amine	Other
Methylamine				X	
Methylamyl Alcohol		X			
Methyl Alcohol			X		
Methyl Bromide	X	X			
Methyl Butyl Ketone	X	X			
Methyl Chloride		X			
Methyl Chloroform	X	X			
Methylcyclohexane	X	X			
Methylcyclohexanol		X			
Methylene Chloride	X	X			
4,4'-Methylenediphenyl Diisocyanate					I1
Methyl Ethyl Ketone	X	X			
Methyl Glycol Acetate	X	X			
Methyl Iodide		X			
Methylisobutyl Carbinol		X			
Methyl Isobutyl Ketone	X	X			
Methyl Methacrylate	X	X			
4-Methyl-2-pentanol		X			
4-Methyl-2-pentanone	X	X			
2-Methyl-2-penten-4-one	X	X			
4-Methyl-3-penten-2-one	X	X			
2-Methyl-2-propanol	X	X			
Methyl Propyl Ketone	X	X			
N-Methyl-2-pyrrolidone (vapour)				X	
alpha-Methylstyrene	X	X			
Methyl Styrene	X	X			
Monochlorodifluoromethane		X			
Naphthalene		X			
Nitrobenzene			X		
Nitropropane			X		
2-Nitropropane			X		
Nitrotoluene			X		
Nitrous Oxide					L2
Octane	X	X			
Pentane (all isomers)	X	X			

Substance	ORSA	Activated Charcoal	Silica Gel	Amine	Other
2-Pentanone	X	X			
Pentyl Acetate		X			
Perchloroethane	X	X			
Perchloroethylene	X	X			
Phenol			X		
Phenylethylene	X	X			
Propanol (all isomers)	X	X			
2-Propenal					A4
2-Propen-1-ol		X			
Propyl Acetate (all isomers)	X	X			
Propyl Alcohol (all isomers)	X	X			
Propylene Dichloride	X	X			
1,2-Propylene Oxide	X	X			
n-Propyl Nitrate		X			
Pyridine	X	X			
R-11		X			
R-12		X			
R-21		X			
R-112	X	X			
R-113	X	X			
R-114	X	X			
Styrene	X	X			
TDI					I1
1,1,1,2-Tetrachloro-2,2-difluoroethane	X	X			
1,1,2,2-Tetrachloro-1,2-difluoroethane	X	X			
1,1,2,2-Tetrachloroethane	X	X			
Tetrachloroethylene	X	X			
Tetrachloromethane	X	X			
Tetrahydrofuran	X	X			
Toluene	X	X			
Toluene Diisocyanate					I1
Toluene-2,4-diisocyanate					I1
Toluene-2,6-diisocyanate					I1
1,1,1-Trichloroethane	X	X			
1,1,2-Trichloroethane	X	X			

Substance	ORSA	Activated Charcoal	Silica Gel	Amine	Other
Trichloroethylene	X	X			
Trichlorofluoromethane	X	X			
Trichloromethane	X	X			
1,2,3-Trichloropropane	X	X			
1,1,2-Trichloro-1,2,2-trifluoroethane	X	X			
Triethylamine				X	
Trifluorobromomethane	X	X			
Trimethylbenzene	X	X			
3,5,5-Trimethyl-2-cyclohexen-1-one	X	X			
Turpentine		X			
Vinyl Acetate	X	X			
Vinylbenzene	X	X			
Vinyl Chloride		X			
Vinylidene Chloride	X	X			
n-Vinyl-2-pyrrolidone				X	
Vinyltoluene	X	X			
Xylene (all isomers)	X	X			

4.7 Dräger-Chips

Chip	Measuring Range	Order Code	Page
Acetic Acid	2 - 50 ppm	64 06 330	376
Acetone	40 - 600 ppm	64 06 470	376
Ammonia	0.2 - 5 ppm	64 06 550	377
Ammonia	2 - 50 ppm	64 06 130	377
Ammonia	10 - 150 ppm	64 06 020	378
Ammonia	100 - 2000 ppm	64 06 570	378
Benzene	50 - 2500 ppb	64 06 600	379
Benzene	0.2 - 10 ppm	64 06 030	379
Benzene	0.5 - 10 ppm	64 06 160	380
Benzene	10 - 250 ppm	64 06 280	380
Butadiene	1 - 25 ppm	64 06 460	381
Carbon Dioxide	200 - 3000 ppm	64 06 190	381
Carbon Dioxide	1000 - 25000 ppm	64 06 070	382
Carbon Dioxide	1 - 20 Vol.-%	64 06 210	382
Carbon Monoxide	5 - 150 ppm	64 06 080	383
Chlorine	0.2 - 10 ppm	64 06 010	383
Ethanol	100 - 2500 ppm	64 06 370	384
Ethylene Oxide	0.4 - 5 ppm	64 06 580	384
Formaldehyde	0.2 - 5 ppm	64 06 540	385
Hydrochloric Acid	1 - 25 ppm	64 06 090	385
Hydrochloric Acid	20 - 500 ppm	64 06 140	386
Hydrocyanic Acid	2 - 50 ppm	64 06 100	386
Hydronen Peroxide	0.2 - 2 ppm	64 06 440	387
Hydrogen Sulfide	0.2 - 5 ppm	64 06 520	387
Hydrogen Sulfide	2 - 50 ppm	64 06 050	388
Hydrogen Sulfide	20 - 500 ppm	64 06 150	388
Hydrogen Sulfide	100 - 2500 ppm	64 06 220	389
Mercaptan	0.25 - 6 ppm	64 06 360	389
Methanol	20 - 500 ppm	64 06 380	390
Methylene Chloride	10 - 200 ppm	64 06 510	390
MTBE	10 - 200 ppm	64 06 530	391
Nitrogen Dioxide	0.5 - 25 ppm	64 06 120	391
Nitrous Fumes	0.5 - 15 ppm	64 06 060	392
Nitrous Fumes	10 - 200 ppm	64 06 240	392
Oxygen	1 - 30 Vol.-%	64 06 490	393

Chip	Measuring Range	Order Code	Page
Ozone	25 - 1000 ppb	64 06 430	393
Perchloroethylene	5 - 150 ppm	64 06 040	394
Petroleum Hydrocarbons	20 - 500 ppm	64 06 200	394
Petroleum Hydrocarbons	100 - 3000 ppm	64 06 270	395
Phosgene	0.05 - 2 ppm	64 06 340	395
Phosphine	0.1 - 2.5 ppm	64 06 400	396
Phosphine	1 - 25 ppm	64 06 410	396
Phosphine	20 - 500 ppm	64 06 420	397
Phosphine	200 - 5000 ppm	64 06 500	397
Propane	100 - 2000 ppm	64 06 310	398
i-Propanol	40 - 1000 ppm	64 06 390	398
Styrene	2 - 40 ppm	64 06 560	399
Sulfur Dioxide	0.4 - 10 ppm	64 06 110	399
Sulfur Dioxide	5 - 150 ppm	64 06 180	400
Toluene	10 - 300 ppm	64 06 250	400
Trichlorethylene	5 - 100 ppm	64 06 320	401
Vinyl Chloride	0.3 - 10 ppm	64 06 170	401
Vinyl Chloride	10 - 250 ppm	64 06 230	402
Water Vapor	0.4 - 10 mg/L	64 06 450	402
o-Xylene	10 - 300 ppm	64 06 260	403
Training Chip	Simulation	64 06 290	403

5. Data and Tables

5.1 Dräger-Tube Measurement System

5.1.1 Explanation to the Data about Dräger-Tubes

Dräger-Tube

The name, type designation and part number of the Dräger-Tube are given. The name of the tube indicates the particular contaminant that the tube has been calibrated to measure. The type designation consists of numbers and of a letter. As a general rule, the number indicates the lower end of the measuring range (in ppm, mg/m³, mg/L or Vol.-%). The letter following the number designates some change to the tube, typically the result of some improvement by further development (e. g. the Dräger-Tube Acetone 100/b). To characterise the Dräger-Diffusion-Tubes with direct indicating, the letter "D" is added (e. g. the Dräger-Diffusion-Tube Ammonia 20/a-D).

Standard Measuring Range

The standard measuring range is calibrated at 20 °C and 1013 hPa (i. e. 1013 mbar). Accordingly, the number of pump strokes for the short-term tubes and the sampling time intervals for the diffusion tubes must be observed.

The instruction sheet packaged with each box of Dräger-Tubes should be consulted for all pertinent details. Furthermore, the measuring range for the Dräger-Tubes for short-term measurement is valid only when the Dräger-Tubes are used in conjunction with a Dräger-Tube pump.

Number of Strokes (n)

The number of pump strokes listed for a given short-term Dräger-Tube reflects the calibrated sample volume necessary for a given measuring range, using the Dräger-Tube pump.

For the Dräger-Tubes with a printed scale (i. e. scaled tubes), only the number of strokes which relate directly to the numerical values of the scale are given. For color intensity tubes (i. e. color match tubes), the highest and lowest number of strokes necessary to obtain a certain discoloration (i. e. determine the concentration) are indicated.

Time for Measurement

The average time for the completion of one measurement, related to the standard measuring range is given in seconds or minutes.

Standard Deviation

The standard deviation is a measure of the incidental deviations of the indicated values from their mean value. The standard deviation, which is actually a coefficient of variation (i.e. relative standard deviation), is given as a percentage and relates to the mean value. According to the first confidence interval 1σ , as it applies to Dräger-Tubes, 68.3 % of all measured values are within this standard deviation range.

For example:

Mean value	500 ppm
Standard Deviation	50 ppm

$$\text{Relative standard deviation} = \frac{50 \cdot 100}{500} = 10 \%$$

Color Change

The color of the indicating layer in the unused Dräger-Tube and the expected color change of the indicating layer in the presence of the particular contaminant is given (e. g. white → brownish green) as well as with a colored photo.

Attention:

Differences in the color of the printed photo and the real tube are possible due to variations of the printing process!

Ambient Operating Conditions

The measuring range of a Dräger-Tube is influenced by the ambient temperature and humidity. The recommended temperature range is given in degree centigrade and the absolute humidity limits are given in mg H₂O/L. Dräger-Tubes are calibrated at an atmospheric pressure of 1013 hPa (i. e. 1013 mbar). To correct for the influence of pressure, the value read from the tube scale must be multiplied by the following correction factor:

$$\text{Correction Factor} = \frac{1013 \text{ hPa}}{\text{actual atmospheric pressure in hPa}}$$

Reaction Principle

The reaction principle lists the basic reactants and the products of the reaction.

Cross Sensitivity

Dräger-Tubes are calibrated for a specific contaminant, but under other than ideal conditions, other interfering contaminants may also be present. Other contaminants that influence the indication are described as being cross sensitive.

The information given under the Cross Sensitivity section indicates which contaminants can influence the indication and which contaminants would not influence the indication. However, this information does not address all possibilities. The influence of other contaminants should be reviewed with the Dräger technical services department.

Extension of the Measuring Range

If the standard measuring range of a Dräger-Tube can be expanded by taking more or fewer pump strokes, the information, including pump strokes, correction factors, etc. will be given. If there is no information given, please contact the Dräger technical services group.

Additional Information

Supplementary points that must be considered when conducting a Dräger-Tube measurement are given here.

5.1.2 Data about Dräger-Tubes for Short-Term Measurements

Methyl Bromide 0.2/a

Order No. 81 03 391

M

Application Range

Standard Measuring Range:	0.2 to 2 ppm	/ 2 to 8 ppm
Reverse activation (n)	1 (1A)	/ 1 (1A)
Number of Strokes n:	5	/ 2
Time for Measurement:	approx. 8 min.	/ approx. 4 min.
Standard Deviation:	± 15 to 20 %	
Color Change:	light color → green	

Ambient Operating Conditions

Temperature:	2 to 40 °C
Absolute Humidity:	< 20 mg/L

Reaction Principle

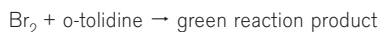
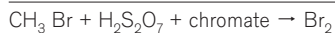

Cross Sensitivity

Vinyl chloride or carbon tetrachloride: < 2 ppm no indication. Methyl bromide cannot be measured in the presence of perchloroethylene or trichloroethylene. Sulfuryl fluoride, phosphine, ethylene oxide, ammonia, hydrocyanic acid, chloropicrin and formaldehyde below their AGW/TLV values are not indicated. Ethylene dibromide is indicated with 1.2 times its sensitivity.

Additional Informations

One reverse activation stroke with air or gas sample



D-18337-2010

Methyl Bromide 0.5/a

Order No. 81 01 671

Application Range

Standard Measuring Range:	5 to 30	/ 0.5 to 5 ppm
Number of Strokes n:	2	/ 8
Time for Measurement:	approx. 2 min	/ approx. 5 min
Standard Deviation:	± 15 to 20 %	
Color Change:	white → blue green	

Ambient Operating Conditions

Temperature:	2 to 40 °C
Absolute Humidity:	max. 20 mg H ₂ O / L

Reaction Principle

- a) $\text{CH}_3\text{Br} + \text{H}_2\text{S}_2\text{O}_7 \rightarrow \text{HBr}$
 b₁) $\text{HBr} + \text{Cr}^{\text{VI}} \rightarrow \text{Br}_2$
 b₂) $\text{Br}_2 + \text{o-tolidine} \rightarrow \text{blue green reaction product}$

Cross Sensitivity

Vinyl chloride:	2 ppm no reading.
Carbon tetrachloride:	2 ppm no reading
Perchloroethylene and Trichloroethylene:	5 ppm changes the indicating layer to a light yellow.
1,2-dichloroethylene:	20 ppm result in a reading of approx. 3 ppm.
1,1-dichloroethylene:	up to 2 ppm the sensitivity is the same as with methyl bromide.



D-5449-2014

Methyl Bromide 3/a

Order No. 67 28 211

M

Application Range

Standard Measuring Range:	10 to 100 / 3 to 35 ppm
Number of Strokes n:	5 activation strokes in methyl bromide free air before testing. 2 / 5
Time for Measurement:	approx. 1 min / approx. 2.5 min
Standard Deviation:	± 10 to 15 %
Color Change:	pale grey green → blue grey

Ambient Operating Conditions

Temperature:	0 to 40 °C
Absolute Humidity:	5 to 12 mg H ₂ O / L

Reaction Principle

- $\text{CH}_3\text{Br} + \text{H}_2\text{S}_2\text{O}_7 \rightarrow$ gaseous cleavage product
- Gaseous cleavage product + $\text{KMnO}_4 \rightarrow \text{Br}_2$
- $\text{Br}_2 + \text{Diphenylbenzidine} \rightarrow$ blue grey reaction product

Cross Sensitivity

Other chlorinated hydrocarbons are indicated, but with different sensitivities.

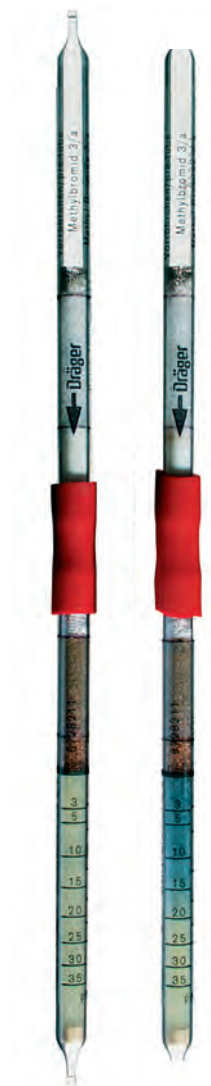

ST-5762-2004

Methyl Bromide 5/b

Order No. CH 27 301

Application Range

Standard Measuring Range:	5 to 50 ppm
Number of Strokes n:	5
Time for Measurement:	approx. 1 min.
Standard Deviation:	± 20 to 30 %
Color Change:	green → brown

Ambient Operating Conditions

Temperature:	0 to 40 °C
Absolute Humidity:	3 to 15 mg H ₂ O / L

Reaction Principle

- a) $\text{CH}_3\text{Br} + \text{SO}_3 + \text{MnO}_4^- \rightarrow \text{Br}_2$
 b) $\text{Br}_2 + o\text{-dianisidine} \rightarrow \text{brown reaction product}$

Cross Sensitivity

Other chlorinated hydrocarbons, free halogens and halogenated hydrocarbon acids are also indicated, however, with differing sensitivities.



5.2.2 Data about Dräger Chips for Short-Term Measurements

5.3 Physical, Chemical, and Toxicological Data for selected Substances

5.3.1 Explanation to the Physical, Chemical, and Toxicological Data

The table lists physical, chemical and toxicological data for many of the airborne contaminants that can be measured using direct reading Dräger detector tubes or Dräger-Chips. This table is intended to serve as a convenient reference source. The information was compiled from relevant technical publications, however, Dräger is not responsible for any use or misuse of the information. The given data, especially the threshold limit values, are current as of AGW-Value: November 2014; TLV-Value: November 2014; WEL-Value: November 2014.

Chemical Name

The common names are given in alphabetical order.

CAS-Number

The CAS-Number is an identification number of the **C**hemical **A**bstract **S**ervice (CAS).

Chemical Formula

The format is molecular, showing the actual number and kind of atoms.

Molecular Weight

The molecular weight listed in the table is given as Kg/Kmol.

Limit Values

The limit values listed for the gases, vapors and aerosols in the table are given in units of ml/m³ (ppm) or mg/m³. The ml/m³ units are given independent of temperature and pressure, but the mg/m³ values are based on 20 °C and 1013 hPa (mbar).

German **AGW-values**¹⁾: In addition to the 8-hour average of the 40-hour workweek the limitation of the peak exposure (peak limit / factor of exceeding) is given in line with the TRGS 900. In case that in the TRGS 900 no values are published then the values of the DFG list are used (Note "DFG" is used).

With 1) marked values:

Workplace limit values corresponding to the proposed tolerable cancer risk. (see TRGS 900)

With 2) marked values:

Workplace limit values corresponding to the proposed preliminary acceptable cancer risk.

The workplace exposure limits of the USA are the TLV values (Threshold Limit Values). The values of the NIOSH list are used. In case that in the NIOSH list no values are published then the values of the OSHA list are used (Note "OSHA" is used).

The WEL-values are the valid Workplace Exposure Limits of UK.

[WEL-Values in brackets]:

The UK Advisory Committee on Toxic Substances has expressed concern that, for the OELs shown in parentheses, health may not be adequately protected because of doubts that the limit was not soundly-based. These OELs were included in the published UK 2002 list and its 2003 supplement, but are omitted from the published 2005 list.

For both limit values the TWA-value (Time-Weighted Average) and the STEL-value (Short-Term Exposure Limit) have approximately the same meaning as the AGW average value and the AGW peak exposure.

Conversion Factors

These factors provide for quick conversion from ml/m³ (ppm) to mg/m³ and mg/m³ to ml/m³.

Vapor Pressure

The pressure at any given temperature of a vapor in equilibrium with its liquid or solid state. The data in the table relates to 20 °C and is given in hPa (mbar).

Relative Vapor Density

The relative vapor density is the relationship of the weight of the vapor to air (air = 1).

Melting Point

The melting point is given in °C at 1013 hPa (mbar).

Boiling Point

The boiling point is given in °C at 1013 hPa (mbar). If the substance sublimates, the abbreviation "subl." is given. If the substance decomposes, the abbreviation "decom." is given.

UN-Number

This is a four digit international identification number assigned to a substance or substance group by the United Nations for the transportation of dangerous goods.

Group and Hazard Class (VbF)

The groups and hazard classes are in accordance with the "Verordnung über brennbare Flüssigkeiten-VbF" (Regulations on flammable liquids).

1. Group A:

Liquids which have a flash point which do not exceed 100 °C and which do not have the properties of Group B with regard to water solubility.

Hazard Class I:

Liquids with a flash point below 21 °C.

Hazard Class II:

Liquids with a flash point between 21 °C and 55 °C.

Hazard Class III:

Liquids with a flash point between 55 °C and 100 °C.

2. Group B:

Liquids with a flash point below 21 °C, which dissolve in water in any arbitrary ratio at 15 °C or the flammable liquid components of which dissolve in water in any ratio at 15 °C.

Ignition Temperature

The ignition temperature is the lowest temperature at which a flammable gas/air or vapor/air mixture will just ignite. The temperature is given in °C at 1013 hPa (mbar).

Lower Ignition Limit and Upper Ignition Limit

Flammable gases or vapors, mixed with air, are explosive within a given concentration range. In this table, the concentration range is given in percent by volume of the gas or vapor, mixed with air, in which ignition by an external ignition source is possible. The values are given at 20 °C and 1013 hPa (mbar).

Smelling Point

The smelling point concentration is given from informations out of different literature and deviates sometimes. The concentrations in this table should be for orientation only.

Note

A dash signifies the information is not known or unavailable, it does not denote a zero.

5.3.2 Table of Physical, Chemical, and Toxicological Data for selected Substances

		Methyl bromide	Methyl chloroformate	Methylene chloride	Methyl ethyl ketone
CAS – Number		[74-83-9]	[79-22-1]	[75-09-2]	[78-93-3]
Chemical Formula		CH ₃ Br	Cl-CO-O-CH ₃	CH ₂ Cl ₂	CH ₃ -CH ₂ -CO-CH ₃
Molecular Weight [Kg/Kmol]		94.94	94.45	84.93	72.2
AGW-Value	ppm = [mL/m ³]	1	0.2	75	200
	[mg/m ³]	3.9	0.78	260	600
Peak Limit	[ppm]	2 (15 min)	0.4 (15 min)	300 (15 min)	300
TLV-Value					
TWA	ppm = [mL/m ³]	–	–	25 (OSHA)	200
	[mg/m ³]	–	–	–	590
STEL	ppm = [mL/m ³]	20 (OSHA)	–	125 (OSHA)	300 (15 min)
	[mg/m ³]	80 (OSHA)	–	–	885 (15 min)
WEL-Value					
TWA	ppm = [mL/m ³]	5	–	100	200
	[mg/m ³]	20	–	350	600
STEL	ppm = [mL/m ³]	15	–	300	300
	[mg/m ³]	59	–	1060	899
Conversion Factors					
1 ppm = 1 mL/m ³ = [mg/m ³]		3.95	3.93	3.53	3.0
[1 mg/m ³] = ppm = mL/m ³		0.25	0.26	0.28	0.33
Vapor Pressure at 20°C [h Pa]		1890	127	470	105
Relative Vapor Density		3.36	3.26	2.93	2.48
Melting Point [°C]		-93.7	-61	-96.7	-86
Boiling Point [°C]		4	71.4	40	80
UN – Number		1062	1238	1593	1193
Group & Hazard Class		–	–	–	A I
Ignition Temperature [°C]		535	504	605	505
Lower Ignition Limit [Vol%]		8.6	10.6	13	1.5
Upper Ignition Limit [Vol%]		20	–	22	12.6
Odor threshold (approx.) ppm		odorless	–	180	< 25

6. Directory of Synonyms

The first column is an alphabetical list of chemical names, trade names and synonyms. When a synonym or trade name is given the appropriate Dräger-Tube or Dräger Chip is listed in the second column with brackets.

Chemical name / Trade name / Synonym	Dräger-Tube / Dräger Chip
Acetaldehyde	[Acetaldehyde]
Acetan	[Ethylene]
Acetene	[Ethylene]
Acetic Acid	[Acetic Acid]
Acetic Acid of Ethyl Ester	[Ethyl Acetate]
Acetic Aldehyde	[Acetaldehyde]
Acetic Ester	[Ethyl Acetate]
Acetic Ether	[Ethyl Acetate]
Acetone	[Acetone]
Acetoxyethane	[Ethyl Acetate]
Acid	[Acid Test]
Acryl Acid of Methyl Ester	[Methyl Acrylate]
Acrylonitrile	[Acrylonitrile]
Acrylonitrile Monomer	[Acrylonitrile]
Alcohol	[Alcohol]
Alcohol Spirits	[Alcohol]
Aldehyde	[Acetaldehyde]
alpha-Trichloroethane	[Trichloroethane]
Amine	[Amine Test]
Aminobenzene	[Aniline]
Aminocyclohexane	[Cyclohexylamine]
Ammonia	[Ammonia]
Ammonium Hydrate	[Ammonia]
Ammonium Hydroxide	[Ammonia]
Anhydrous Ammonia	[Ammonia]
Aniline	[Aniline]
Aniline Oil	[Aniline]
Aqua Ammonia	[Ammonia]
Aqua Fortis	[Nitric Acid]
Aqueous Ammonia	[Ammonia]
Arsenic Hydride	[Arsine]
Arsenic Trihydride	[Arsine]
Arsenious Hydride	[Arsine]
Arsine	[Arsine]
Benzenamine	[Aniline]

Chemical name / Trade name / Synonym	Dräger-Tube / Dräger Chip
Benzene	[Benzene]
Benzene Chloride	[Chlorobenzene]
Benzol	[Benzene]
Benzolphenol	[Phenol]
beta-Chlorobutadiene	[Chloroprene]
Biethylene	[Butadiene]
Bivinyll	[Butadiene]
Bromotrifluoromethane	[Halogenated Hydrocarbons]
Bromomethane	[Methyl Bromide]
BTX	[Benzene]
BTX	[Toluene]
BTX	[Xylene]
Buta-1,3-diene	[Butadiene]
1,3-Butadiene	[Butadiene]
1-Butanethiol	[Tertiary Butylmercaptan]
Butanethiol	[Tertiary Butylmercaptan]
Butyl Mercaptan	[Mercaptan]
Butylene	[Olefine]
Carbinol	[Alcohol]
Carbolic Acid	[Phenol]
Carbon Bisulfide	[Carbon Disulfide]
Carbon Dioxide	[Carbon Dioxide]
Carbon Disulfide	[Carbon Disulfide]
Carbon Monoxide	[Carbon Monoxide]
Carbon Oxide	[Carbon Monoxide]
Carbon Oxychloride	[Phosgene]
Carbon Sulfide	[Carbon Disulfide]
Carbon Tetrachloride	[Carbon Tetrachloride]
Carbonic Acid Gas	[Carbon Dioxide]
Carbonic Anhydride	[Carbon Dioxide]
Carbonic Oxide	[Carbon Monoxide]
Carbonyl Chloride	[Phosgene]
Cecolene 1	[Trichloroethylene]
Cecolene 2	[Perchloroethylene]
Cellosolve Acetate	[Ethyl Glycol Acetate]
CFC	[Halogenated Hydrocarbons]
1-Chlore-2,3-epoxypropane	[Vinyl Chloride]
Chlorine	[Chlorine]

Chemical name / Trade name / Synonym	Dräger-Tube / Dräger Chip
Chlorine Cyanide	[Cyanogen Chloride]
Chlorine Dioxide	[Chlorine Dioxide]
2-Chloro-1,3-butadiene	[Chloroprene]
Chlorobenzene	[Chlorobenzene]
Chlorobenzol	[Chlorobenzene]
Chloroethene	[Vinyl Chloride]
Chloroform	[Chloroform]
Chloroformyl Chloride	[Phosgene]
Chloroformates	[Chloroformates]
Chlorohydric Acid	[Hydrochloric Acid]
Chloropicrine	[Chloropicrine]
Chloroprene	[Chloroprene]
2-Chloropropylene Oxide	[Epichlorohydrin]
Chloropropylene Oxide	[Epichlorohydrin]
Chromic Acid	[Chromic Acid]
Cinnamene	[Styrene]
Creosote Oil	[Phenol]
Cyanide	[Cyanide]
Cyanogen Chloride	[Cyanogen Chloride]
Cyclohexane	[Cyclohexane]
Cyclohexylamine	[Cyclohexylamine]
DDVP	[Phosphoric Acid Esters]
Desmodur H	[Isocyanate Sampling Set]
Desmodur T	[Toluene Diisocyanate]
Di-henvlmethane-4,,4'-diisocyanate	[Isocyanate Sampling Set]
Dialkylsulfide	[Thioether]
Diamine	[Hydrazine]
Dichloromethane	[Methylene Chloride]
1,3-Dichloropropene	Vinyl Chloride
Dichloropropene	Vinyl Chloride
Dichlorvos	[Phosphoric Acid Esters]
Diethyl Ether	[Diethyl Ether]
Diethyl Oxide	[Diethyl Ether]
Diethylaminoethane	[Triethylamine]
Difluorochlorobromomethane	[Halogenated Hydrocarbons]
Difluorochloromethane	[Halogenated Hydrocarbons]
Difluorodichloromethane	[Halogenated Hydrocarbons]
Dihydrooxirene	[Ethylene Oxide]

Chemical name / Trade name / Synonym	Dräger-Tube / Dräger Chip
1,2-Dihydroxyethane	[Ethylene Glycol]
2,4-Diisocyanato-1-methylbenzene	[Toluene Diisocyanate]
2,6-Diisocyanato-1-methylbenzene	[Toluene Diisocyanate]
4,4-Diisocyanatodiphenylmethane	[Isocyanate Sampling Set]
Dimethyl Dichlorovinyl Phosphate	[Phosphoric Acid Esters]
Dimethyl Ester of Sulfuric Acid	[Dimethyl Sulfate]
Dimethyl Formamide	[Dimethyl Formamide]
Dimethyl Sulfate	[Dimethyl Sulfate]
Dimethyl Sulfide	[Dimethyl Sulfide]
Dimethylbenzene	[Xylene]
Dimethylene Oxide	[Ethylene Oxide]
Dimethylketone	[Acetone]
Dimethylmethane	[Propane]
Dinitrogen Tetroxide	[Nitrogen Dioxide]
4,4-Diphenylmethane Diisocyanate	[Isocyanate Sampling Set]
DMF	[Dimethyl Formamide]
Dow-Per	[Perchloroethylene]
Elayl	[Ethylene]
EO	[Ethylene Oxide]
Epichlorohydrin	[Epichlorohydrin]
1,2-Epoxyethane	[Ethylene Oxide]
Erythrene	[Butadiene]
Ethanal	[Acetaldehyde]
1,2-Ethanediol	[Ethylene Glycol]
Ethanoic Acid	[Acetic Acid]
Ethanol	[Alcohol]
Ethene	[Ethylene]
Ether	[Diethyl Ether]
2-Ethoxyethyl Acetate	[Ethyl Glycol Acetate]
Ethyl Acetate	[Ethyl Acetate]
Ethyl Acetic Ester	[Ethyl Acetate]
Ethyl Alcohol	[Alcohol]
Ethyl Aldehyde	[Acetaldehyde]
Ethyl Benzene	[Ethyl Benzene]
Ethyl Chlorcarbonate	[Chloroformates]
Ethyl Chloroformate	[Chloroformates]
Ethyl Ester of Acetic Acid	[Ethyl Acetate]
Ethyl Ether	[Diethyl Ether]

Chemical name / Trade name / Synonym	Dräger-Tube / Dräger Chip
Ethyl Formate	[Ethyl Formate]
Ethyl Glycol Acetate	[Ethyl Glycol Acetate]
Ethyl Mercaptan	[Mercaptan]
Ethyl Oxide	[Diethyl Ether]
Ethylene	[Ethylene]
Ethylene Alcohol	[Ethylene Glycol]
Ethylene Glycol	[Ethylene Glycol]
Ethylene Glycol Monoethyl Ether Acetate	[Ethyl Glycol Acetate]
Ethylene Oxide	[Ethylene Oxide]
Ethylene Tetrachloride	[Perchloroethylene]
Ethylene Trichloride	[Trichloroethylene]
Ethylic Acid	[Acetic Acid]
F 113	[Halogenated Hydrocarbons]
F 114	[Halogenated Hydrocarbons]
F 12	[Halogenated Hydrocarbons]
F 12 B 1	[Halogenated Hydrocarbons]
F 13 B 1	[Halogenated Hydrocarbons]
F 22	[Halogenated Hydrocarbons]
F 11	[Halogenated Hydrocarbons]
Fluorine	[Fluorine]
Fluorotrichloromethane	[Halogenated Hydrocarbons]
Formaldehyde	[Formaldehyde]
Formalin	[Formaldehyde]
Formic Acid	[Formic Acid]
Formic Aldehyde	[Formaldehyde]
Formonitrile	[Hydrocyanic Acid]
Formyl Trichloride	[Chloroform]
Formylic Acid	[Formic Acid]
Freon	[Halogenated Hydrocarbons]
Genklene	[Trichloroethane]
Glacial Acetic Acid	[Acetic Acid]
Glycol	[Ethylene Glycol]
Glysantin	[Ethylene Glycol]
Halogenated Hydrocarbons	[Halogenated Hydrocarbons]
Halon 1211	[Halogenated Hydrocarbons]
Halon 1301	[Halogenated Hydrocarbons]
HDI	[Isocyanate Sampling Set]
Hexahydroaniline	[Cyclohexylamine]

Chemical name /
Trade name / Synonym

Dräger-Tube / Dräger Chip

Hexahydrobenzene	[Cyclohexane]
Hexamethylene	[Cyclohexane]
Hexamethylene Diisocyanate	[Isocyanate Sampling Set]
Hexanaphthene	[Cyclohexane]
Hydrazine	[Hydrazine]
Hydrazine Base	[Hydrazine]
Hydrazine, Anhydrous	[Hydrazine]
Hydrocarbons	[Hydrocarbons]
Hydrochloric Acid	[Hydrochloric Acid]
Hydrocyanic Acid	[Hydrochloric Acid]
Hydrogen	[Hydrogen]
Hydrogen Carboxylic Acid	[Formic Acid]
Hydrogen Chloride	[Hydrochloric Acid]
Hydrogen Cyanide	[Hydrocyanic Acid]
Hydrogen Fluoride	[Hydrogen Fluoride]
Hydrogen Nitrate	[Nitric Acid]
Hydrogen Peroxide	[Hydrogen Peroxide]
Hydrogen Phosphide	[Phosphine]
Hydrogen Sulfate	[Sulfuric Acid]
Hydrogen Sulfide	[Hydrogen Sulfide]
Hydroperoxide	[Hydrogen Peroxide]
Hydrosulfuric Acid	[Hydrogen Sulfide]
Iod	[Iodine]
Iodine	[Iodine]
i-Prapanol	[i-Prapanol]
i-Propanol	[Alcohol]
iso-Propanol	[Alcohol]
iso-Propanol	[i-Prapanol]
Isopropanol	[Alcohol]
Isopropanol	[i-Prapanol]
Ketone Propane	[Acetone]
Krystallin	[Aniline]
Kyanol	[Aniline]
March Gas	[Natural Gas]
MD1	[Isocyanate Sampling Set]
MEG	[Ethylene Glycol]
Mercaptan	[Mercaptan]
Mercury Vapor	[Mercury Vapor]

Chemical name / Trade name / Synonym	Dräger-Tube / Dräger Chip
Methanal	[Formaldehyde]
Methane	[Natural Gas]
Methane Trichloride	[Chloroform]
Methanecarboxylic Acid	[Acetic Acid]
Methanoic Acid	[Formic Acid]
Methanol	[Alcohol]
Methenyl Trichloride	[Chloroform]
Methyl Acrylate	[Methyl Acrylate]
Methyl Alcohol	[Alcohol]
Methyl Bromide	[Methyl Bromide]
Methyl Chlorocarbonate	[Chloroformates]
Methyl Chloroform	[Trichloroethane]
Methyl Chloroformate	[Chloroformates]
Methyl Ester of Acrylic Acid	[Methyl Acrylate]
Methyl Hydroxide	[Alcohol]
Methyl Ketone	[Acetone]
Methyl Mercaptan	[Mercaptan]
Methyl Sulfate	[Dimethyl Sulfate]
Methyl Sulfide	[Dimethyl Sulfide]
Methyl Trichloride	[Chloroform]
Methylbenzene	[Toluene]
Methylene Bisphenyl Isocyanate	[Isocyanate Sampling Set]
Methylene Chloride	[Methylene Chloride]
Methylene Dichloride	[Methylene Chloride]
4,4-Methylenediphenyl Diisocyanate	[Isocyanate Sampling Set]
Methylisothiocyanate	[Methylisothiocyanate]
Methyltrichloromethane	[Trichloroethane]
MITC	[Methylisothiocyanate]
Monobromomethane	[Methyl Bromide]
Monochlorobenzene	[Chlorobenzene]
Monochloroethylene	[Vinyl Chloride]
Monoethylene Glycol	[Ethylene Glycol]
Monohydroxy Benzene	[Phenol]
Monohydroxymethane	[Alcohol]
Mononitrogen Monoxide	[Nitrous Fumes]
Mononitrotrichloromathane	[Chloropicrine]
Monostyrene	[Styrene]
MTBE	[MTBE]

Chemical name / Trade name / Synonym	Dräger-Tube / Dräger Chip
m-Xylene	[Xylene]
Natural Gas	[Natural Gas]
n-Butanol	[Alcohol]
N-Formyldimethylamine	[Dimethyl Formamide]
n-Hexane	[Hexane]
Nickel Carbonyl	[Nickel Tetracarbonyl]
Nickel Tetracarbonyl	[Nickel Tetracarbonyl]
Nitric Acid	[Nitric Acid]
Nitric Oxide	[Nitrous Fumes]
Nitrogen (11) Oxide	[Nitrous Fumes]
Nitrogen Dioxide	[Nitrogen Dioxide]
Nitrogen Peroxide	[Nitrogen Dioxide]
Nitrous Fumes	[Nitrous Fumes]
Normal-Hexane	[Hexane]
Nox	[Nitrous Furnes]
n-Pentane	[Pentane]
Oil	[Oil]
Oil Mist	[Oil Mist]
Oil of Vitriol	[Sulfuric Acid]
Olefine	[Olefine]
Organic Arsenic Compounds	[Organic Arsenic Compounds]
Organic Basic Nitrogen Compounds	[Organic Basic Nitrogen Compounds]
o-Toluidine	[Toluidine]
Oxirane	[Ethylene Oxide]
Oxybenzene	[Phenol]
Oxygen	[Oxygen]
o-Xylene	[Xylene]
Oxymethylene	[Formaldehyde]
Ozone	[Ozone]
Paraformaldehyde	[Formaldehyde]
Perchloroethylene	[Perchloroethylene]
Perchlorornethane	[Carbon Tetrachloridel]
Perclene	[Perchloroethylene]
Perhydrol	[Hydrogen Peroxide]
Perk	[Perchloroethylene]
Perone	[Hydrogen Peroxide]
Petroleum Hydrocarbons	[Petroleum Hydrocarbons]
Phenol	[Phenol]

Chemical name / Trade name / Synonym	Dräger-Tube / Dräger Chip
Phenol Alcohol	[Phenol]
Phenyl Chloride	[Chlorobenzene]
Phenyl Hydride	[Benzene]
Phenyl Hydroxide	[Phenol]
Phenylamine	[Aniline]
Phenylethane	[Ethyl Benzene]
Phenylethene	[Styrene]
Phenylethylene	[Styrene]
Phenylic Acid	[Phenol]
Phenylmethane	[Toluene]
Phosgene	[Phosgene]
Phosphanes	[Phosphine]
Phosphine	[Phosphine]
Phosphoric Acid Esters	[Phosphoric Acid Esters]
Phosphorus Hydride	[Phosphine]
Phosphorus Trihydride	[Phosphine]
Propan-2-ol	[Alcohol]
Propan-2-ol	[i-Prapanol]
Propane	[Propane]
2-Propanol	[Alcohol]
2-Propanol	[i-Prapanol]
2-Propanone	[Acetone]
Propanone-2	[Acetone]
Propenenitrile	[Acrylonitrile]
Propyl Mercaptan	[Mercaptan]
Propylene	[Olefine]
Propylhydride	[Propane]
Proxyllic Spirit	[Alcohol]
Prussic Acid	[Hydrocyanic Acid]
p-Xylene	[Xylene]
Pyrene	[Carbon Tetrachloride]
Pyridine	[Pyridine]
Pyroacetic Ether	[Acetone]
Pyrrolylene	[Butadiene]
R 11	[Halogenated Hydrocarbons]
R 113	[Halogenated Hydrocarbons]
R 114	[Halogenated Hydrocarbons]
R 12	[Halogenated Hydrocarbons]

Chemical name / Trade name / Synonym	Dräger-Tube / Dräger Chip
R 12 B 1	[Halogenated Hydrocarbons]
R 13 B 1	[Halogenated Hydrocarbons]
R 22	[Halogenated Hydrocarbons]
Retinaphtha	[Toluene]
Solvent Ether	[Diethyl Ether]
Styrene Monomer	[Styrene]
Sulfuric Acid	[Sulfuric Acid]
Sulfur Dioxide	[Sulfur Dioxide]
Sulfur Oxide	[Sulfur Dioxide]
Sulfuric Ether	[Diethyl Ether]
Sulfurous Acid Anhydride	[Sulfur Dioxide]
Sulfureted Hydrogen	[Hydrogen Sulfide]
Sulfuryl Fluoride	[Sulfuryl Fluoride]
TDI	[Toluene Diisocyanate]
TEA	[Triethylamine]
Tert. Butylmercaptan	[Tertiary Butylmercaptan]
Tert. Butylmethylether	[MTBE]
Tertiary Butylmercaptan	[Tertiary Butylmercaptan]
Tetrachloroethene	[Perchloroethylene]
Tetrachloroethylene	[Perchloroethylene]
Tetrachloromethane	[Carbon Tetrachloride]
Tetraform	[Carbon Tetrachloride]
Tetrahydrothiophene	[Tetrahydrothiophene]
1,1,2,2,-Tetrafluoro-1,2-dichloroethane	[Halogenated Hydrocarbons]
Thioether	[Thioether]
Thiophane	[Tetrahydrothiophene]
THT	[Tetrahydrothiophene]
Toluene	[Toluene]
2,4-Toluene Diisocyanate	[Toluene Diisocyanate]
2,6-Toluene Diisocyanate	[Toluene Diisocyanate]
Toluene Diisocyanate	[Toluene Diisocyanate]
Toluene-2,4-diisocyanate	[Toluene Diisocyanate]
Toluene-2,6-diisocyanate	[Toluene Diisocyanate]
2,4-Tolylene Diisocyanate	[Toluene Diisocyanate]
2,6-Tolylene Diisocyanate	[Toluene Diisocyanate]
Tri	[Trichloroethylene]
1,1,1-Trichloroethane	[Trichloroethane]
Trichloroethane	[Trichloroethane]

Chemical name / Trade name / Synonym	Dräger-Tube / Dräger Chip
Trichloroethene	[Trichloroethylene]
Trichloroethylene	[Trichloroethylene]
Trichlorofluoromethane	[Halogenated Hydrocarbons]
Trichloromethane	[Chloroform]
Trichloronitromethane	[Chloropicrine]
Triclene	[Trichloroethylene]
Trieline	[Trichloroethylene]
Triethylamine	[Triethylamine]
1,1,2-Trifluoro-1,2,2-trichloroethane	[Halogenated Hydrocarbons]
Trioxane	[Formaldehyde]
Vinegar Naphtha	[Ethyl Acetate]
Vinyl Chloride	[Vinyl Chloride]
Vinyl Cyanide	[Acrylonitrile]
Vinyl Ethylene	[Butadiene]
Vinylbenzene	[Styrene]
Vinylbenzol	[Styrene]
Water Vapor	[Water Vapor]
Wood Alcohol	[Alcohol]
Xylene	[Xylene]
Xylol	[Xylene]

Not all products, features, or services are for sale in all countries.
Mentioned Trademarks are only registered in certain countries and not necessarily in the country in which this material is released. Go to www.draeger.com/trademarks to find the current status.

CORPORATE HEADQUARTERS

Drägerwerk AG & Co. KGaA
Moislinger Allee 53–55
23558 Lübeck, Germany

www.draeger.com

Manufacturer:

Dräger Safety AG & Co. KGaA
Revalstraße 1
23560 Lübeck, Germany

REGION DACH

Dräger Safety AG & Co. KGaA
Revalstraße 1
23560 Lübeck, Germany
Tel +49 451 882 0
Fax +49 451 882 2080
info@draeger.com

REGION EUROPE

Dräger Safety AG & Co. KGaA
Revalstraße 1
23560 Lübeck, Germany
Tel +49 451 882 0
Fax +49 451 882 2080
info@draeger.com

REGION MIDDLE EAST, AFRICA

Dräger Safety AG & Co. KGaA
Branch Office P.O. Box 505108
Dubai, United Arab Emirates
Tel +971 4 4294 600
Fax +971 4 4294 699
contactuae@draeger.com

REGION ASIA PACIFIC

Dräger Singapore Pte. Ltd.
25 International Business Park
#04-20/21 German Centre
Singapore 609916
Tel +65 6308 9400
Fax +65 6308 9401
asia.pacific@draeger.com

REGION CENTRAL AND SOUTH AMERICA

Dräger Panama S. de R.L.
59 East Street, Nuevo Paitilla,
House 30, San Francisco Town
Panama City, Panama
Tel +507 377 9100
Fax +507 377 9130
servicioalcliente@draeger.com

Locate your Regional Sales
Representative at:
www.draeger.com/contact



APPENDIX C - FIELD FORM

Appendix C

FIELD FORM FOR AMBIENT AIR MONITORING WITH DRAEGER-TUBE SAMPLING SYSTEM

Date:	
Sampling Location:	
Facility Name:	
Facility Address:	
Fumigation Location (circle all that apply)	C Shed F Shed G Shed
Sampler Name:	
Pump Model, Manufacturer & Serial Numbers:	
Detection Tube Manufacturer, Targeted Chemical:	
Reagent Color Change if Targeted Chemical is Detected:	

SAMPLING SETUP AND METEOROLOGICAL CONDITIONS:

Time Setup Complete:	AM or PM
Height of Tubes above ground surface*:	feet and inches
Ambient Temperature:	
Absolute Humidity:	
Barometric Pressure:	
Precipitation Type and Intensity:	
Wind Speed and Direction:	
Pump Leak Test Performed and Passed?	<input type="checkbox"/> Yes or <input type="checkbox"/> No
Tube opened on both ends?	<input type="checkbox"/> Yes or <input type="checkbox"/> No
Direction Tube Tip is Facing*:	
Notes on Area Operations:	

*The height of tubes and direction tip is facing should be consistent with other sampling events at this same location.

Appendix C

SAMPLING:

Application Range Standard Measuring Range	<input type="checkbox"/> 0.1 to 5 ppm or <input type="checkbox"/> 5 to 50 ppm
Number of Strokes n:	<input type="checkbox"/> 10 or <input type="checkbox"/> 2
Time for Measurement:	<input type="checkbox"/> approx. 8 min. or <input type="checkbox"/> approx. 4 min.
Start Time of Sampling Period:	
End Time of Sampling Period:	
Resulting Concentration:	parts per million (ppm)

Additional Notes:



CREATE AMAZING.

Burns & McDonnell World Headquarters
9400 Ward Parkway
Kansas City, MO 64114
O 816-333-9400
F 816-333-3690
www.burnsmcd.com

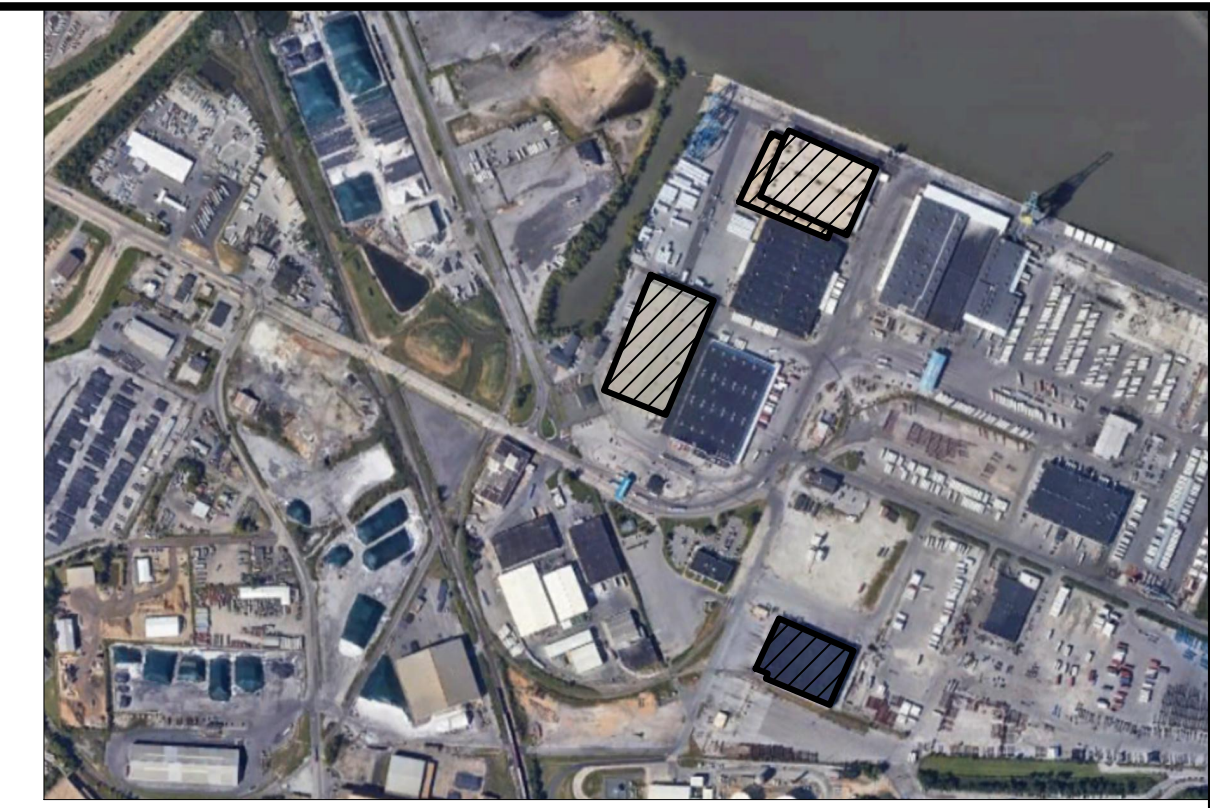

VICINITY MAP
NOT TO SCALE

LEGEND:

- · — · — EDGE OF WATER
- ===== CURB
- x — x — FENCE LINE
- · — · — EDGE OF BITUMINOUS PAVING
- · — · — BOUNDARY LINE
- · — · — ADJOINER LINE
- · — · — LEGAL RIGHT-OF-WAY LINE
- - - - - EXISTING 1' CONTOUR
- - - - - EXISTING 5' CONTOUR
- E — OVERHEAD ELECTRIC LINE
- E&T — OVERHEAD ELECTRIC & TELEPHONE LINE
- T — OVERHEAD TELEPHONE LINE
- G — GAS LINE
- ⊙ ELECTRIC POLE
- ⊙ GUY POLE
- ^ GUY WIRE
- ⊙ FIRE HYDRANT
- ⊙ WATER VALVE
- ⊙ GAS METER
- ⊙ GAS VALVE
- GAS MARKER
- STORM SEWER INLET
- STORM SEWER MANHOLE
- CLEANOUT
- ⊙ SANITARY SEWER MANHOLE
- ⊙ UNKNOWN MANHOLE
- BOLLARD
- > - > - > - EXHAUST DIRECTION
- ⊙ EXHAUST STACK
- ▨ EXISTING SHROUD

no.	date	by	ckd	description
A	11/16/22	PRF	SC	ISSUED FOR REFERENCE

- NOTES:**
- SITE TOPOGRAPHY IS BASED ON SURVEY COMPLETED JUNE 2022 BY DAWOOD ENGINEERING.
 - SITE COORDINATE SYSTEM IS BASED ON DELAWARE STATE PLANE NAD 83 (CORS 96). CONTOUR ELEVATIONS ARE BASED ON NAVD 88 VERTICAL DATUM.
 - CONTOUR INTERVAL IS 1-FOOT.
 - SUBSURFACE UTILITIES ARE SHOWN RELATIVE TO THE LOCATION OF THEIR SURFACE FEATURE LOCATIONS. CONTRACTOR SHALL BE RESPONSIBLE FOR LOCATING ALL EXISTING UTILITIES.
 - THIS SITE LIES WITHIN A FLOOD HAZARD ZONE 'AE' AS SHOWN ON FLOOD INSURANCE RATE MAP COMMUNITY PANEL 10003C0156L AN EFFECTIVE DATE OF JANUARY 22, 2020; 10003C0157L AN EFFECTIVE DATE OF JANUARY 22, 2020; 10003C0158K AN EFFECTIVE DATE OF FEBRUARY 4, 2015; 10003C0159K AN EFFECTIVE DATE OF FEBRUARY 4, 2015, FOR THE CITY OF WILMINGTON, DELAWARE, NEW CASTLE COUNTY.
 - BENCHMARK IS A BENCHMARK DISK JU1778 STAMPED 'X 21 1959' LOCATED IN THE CONCRETE VAULT. TOP ELEVATIONS IS 7.80' (NAVD 88 DATUM).

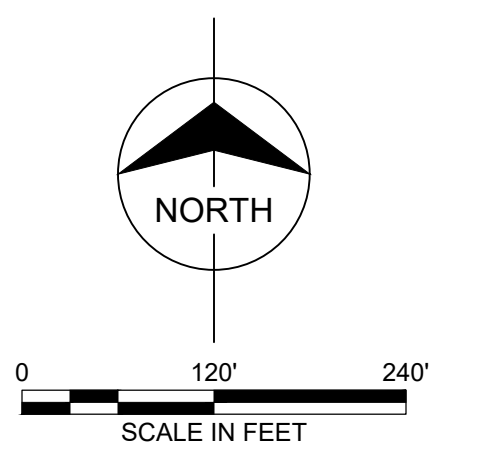

REFERENCE DRAWING

**BURNS
MEDONNELL**
9400 WARD PARKWAY
KANSAS CITY, MO 64114
816-333-9400
LICENSEE NO. 000165

date	11/16/2022	detailed	P. RUIZ FABIAN
designed	P. RUIZ FABIAN	checked	S. CRONIN

ECOLAB
ECOLAB
WILMINGTON, DELAWARE

ECOLAB AIR DISPERSION
SITE PLAN
EXISTING EXHAUST LAYOUT

project	124778	contract	-
drawing		rev.	
FIGURE 1 —		A	
sheet	of	sheets	
file Figure 1 - Existing Exhaust Layout.dwg			

F - SHED General Layout

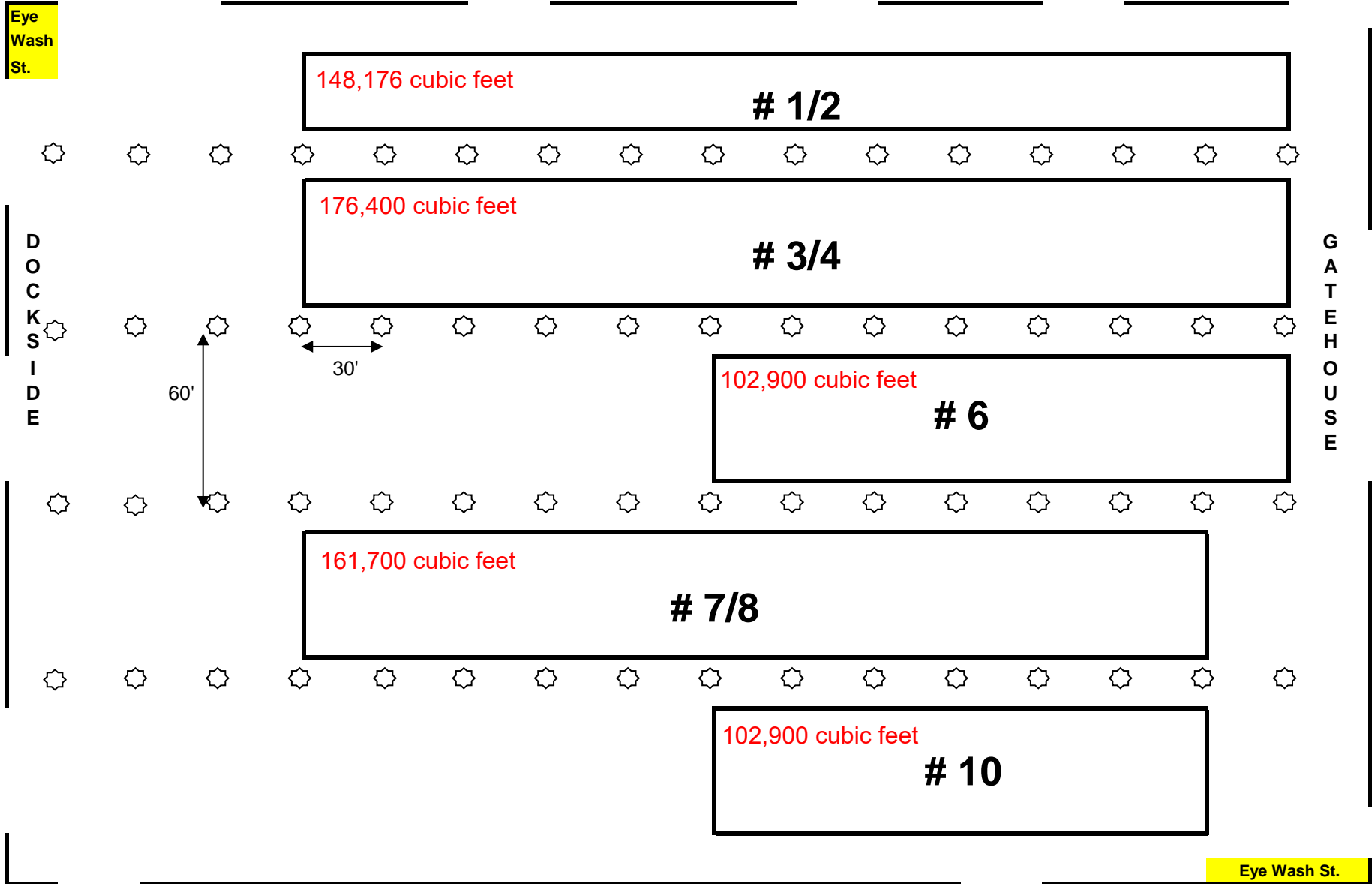



Photograph 1: View beneath empty shroud, Warehouse F.



Photograph 2: Fruit pallets beneath shroud, Warehouse F.

Ecolab, Inc.
Pest Elimination Division



Fumigation Operations
Port of Wilmington, DE



Photograph 3: Exhaust connection point on lowered shroud, Warehouse F.



Photograph 4: Exhaust connection point on elevated shroud, Warehouse F.



Photograph 5: Exhaust blower and shroud fan in elevated shroud, Warehouse F.



Photograph 6: Exhaust blower, shroud fan and flexible hose connections, Warehouse F.

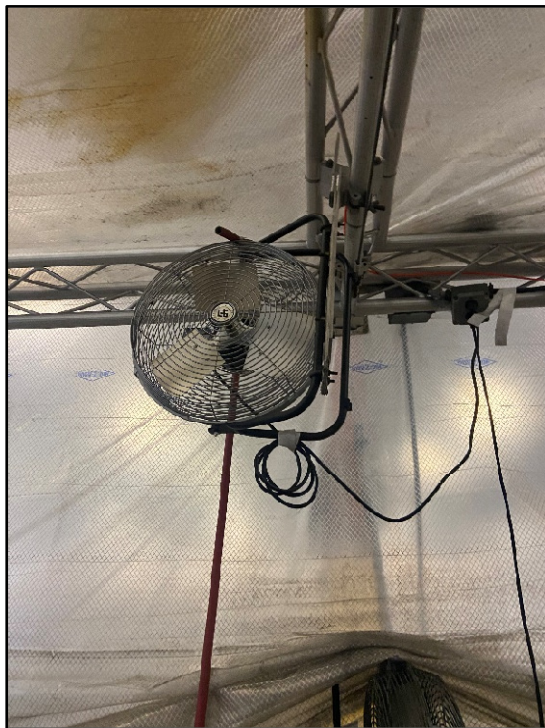

Photograph 7: Fan to circulate fumigant in shroud, Warehouse F.



Photograph 8: Lowered shroud and blower connection point without flexible hoses.



Photograph 9: Blower and connection point without flexible hose, Warehouse F.



Photograph 10: Fumigant tanks on carts outside shroud, Warehouse F.

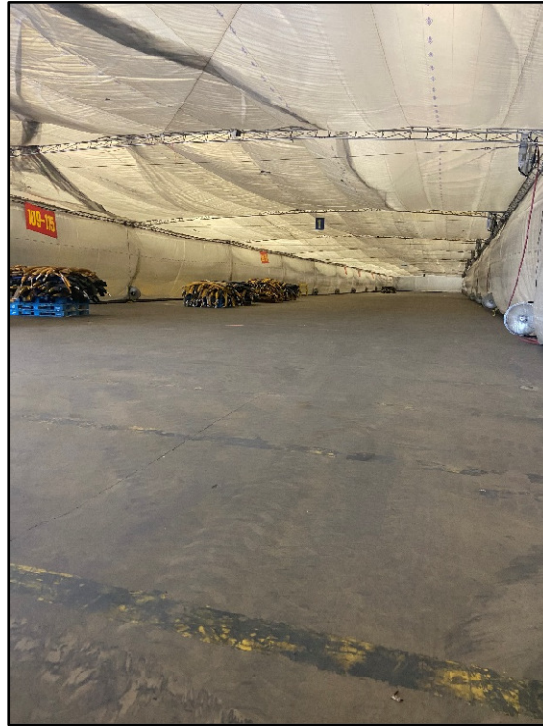

Photograph 11: View inside empty shroud, Warehouse F.



Photograph 12: Example of pallet staging within shroud, Warehouse F.